

ADEMCO VISTA-10P
ADEMCO VISTA-10PSIA
Security Systems

Programming Guide

COMPATIBILITY: This Programming Guide is intended for VISTA-10P/VISTA-10PSIA controls with firmware revision 4.0 or higher.

IMPORTANT: The Real-Time Clock must be set before the end of the installation. See procedure in the Setting the Real-Time Clock section of this manual.

TABLE of CONTENTS

PROGRAMMING OVERVIEW	3
DATA FIELD PROGRAMMING FORM	4
DIALER PROGRAMMING.....	5
SYSTEM STATUS REPORT CODES.....	6
RESTORE REPORT CODES	7
OUTPUT AND SYSTEM SETUP	7
DOWNLOAD INFORMATION.....	8
PAGER OPTIONS.....	8
MISCELLANEOUS SYSTEM FIELDS.....	9
CONFIGURABLE ZONE TYPE OPTIONS	9
KEYPAD OPTIONS.....	10
CONFIGURABLE ZONE TYPES WORKSHEETS	11
*56 ZONE PROGRAMMING MENU MODE.....	12
*58 EXPERT PROGRAMMING MODE	13
WIRELESS KEY PROGRAMMING TEMPLATES	14
*57 FUNCTION KEY PROGRAMMING MODE	15
OUTPUT DEVICE PROGRAMMING OVERVIEW (*79/*80 MENU MODE).....	15
*79 OUTPUT DEVICE MAPPING.....	16
*80 OUTPUT DEFINITION MODE.....	16
*81 ZONE LIST PROGRAM MODE	18
*82 ZONE DESCRIPTOR PROGRAMMING MODE	18
ADDING CUSTOM WORDS.....	19
ALPHA VOCABULARY LIST (For Entering Zone Descriptors).....	20
SCHEDULING MODE.....	21
*29 COMMUNICATION DEVICE MENU MODE (Pass-Through Programming).....	22
UPLOADING/DOWNLOADING VIA THE INTERNET.....	23
SETTING THE REAL-TIME CLOCK	23
ZONE TYPE DEFINITIONS	24
SYSTEM COMMUNICATION	25
Report Code Formats.....	25
Ademco Contact ID®.....	26
TABLE OF DEVICE ADDRESSES	27
UL NOTICES.....	27
SIA QUICK REFERENCE GUIDE	27
5800 SERIES TRANSMITTER INPUT LOOP IDENTIFICATION.....	28
SCHEDULE WORKSHEET	29
*56 ZONE PROGRAMMING WORKSHEET	29
*57 FUNCTION KEY PROGRAMMING WORKSHEET	30
*79 RELAY MAPPING WORKSHEET	30
*80 OUTPUT DEFINITIONS WORKSHEET	30
*81 ZONE LISTS WORKSHEET	31
VARIOUS SYSTEM TROUBLE DISPLAYS	31

PROGRAMMING OVERVIEW

You can program the system at any time, even at the installer's premises prior to the actual installation. Programming can also be performed remotely from the installer's office/home, using an IBM personal computer, a modem, and Compass downloading software.

TO ENTER PROGRAMMING MODE:

Local programming requires the use of an alpha keypad connected to the keypad terminals on the control.

- A. POWER UP, then depress **[*]** and **[#]** both at once, within 50 seconds of powering up (if ***98** was used to exit previously, this method must be used to reenter program mode). OR
- B. Initially, key: **Installer Code (4 + 1 + 1 + 2)** plus **8 + 0 + 0**.

Data Field Programming Procedures

Task	Procedure
Go to a Data Field	Press [*] + [Field Number] , followed by the required entry.
Entering Data	When the desired field number appears, simply make the required entry. When the last entry for a field is entered, the keypad beeps three times and automatically displays the next data field in sequence. If the number of digits that you need to enter in a data field is less than the maximum digits available (for example, the phone number fields *41, *42), enter the desired data, then press [*] to end the entry. The next data field is displayed.
Review a Data Field	Press [#] + [Field Number] . Data will be displayed for that field number. No changes will be accepted in this mode.
Deleting an Entry	Press [*] + [Field Number] + [*] . (Applies only to fields *40–*44, *94, and pager programming fields)

Interactive Menu Mode Programming (*29, *56, *57, *58, *79, *80, *81, *82)

See respective sections in this document for programming procedures.

Press **[*]** + **[Menu Mode No.]** (for example, ***56**). The alpha display keypad will display the first of a series of prompts.

The following is a list of the various Programming modes used to program this system:

Programming Mode...	Used to ...
Data Field Programming	Program basic data fields used for setting the various system options. Most of the data fields in this system have been programmed for specific default values. However, some fields must be programmed for each particular installation to establish its specific alarm and reporting features.
*29 IP/GSM Programming	Program the IP and/or GSM options from a keypad.
*56 Zone Programming	Assign zone characteristics, report codes, alpha descriptors, and serial numbers for 5800 RF transmitters.
*57 Function Key Programming	Program each of the four alphabet function keys to perform one of several system operations.
*58 Zone Programming (Expert Mode)	Assign zone attributes similar to *56 mode, but provides a faster programming procedure and is intended for those more experienced in programming controls of this type.
*79 Output Device Mapping	Assign device address of the 4204 Relay module and map the specific relays
*80 Output Definitions	Define up to 12 output definitions which can control the output relays mapped using *79 Output Device Mapping mode.
*81 Zone List Programming	Create Zone Lists for relay zones, chime, night-stay, cross zones, and pager zones.
*82 Alpha Programming	Create alpha descriptors for easy zone identification.
Scheduling Mode (code + [#] +64)	Create schedules to automate various system functions.
Site-Initiated Download	Installer code + [#] + 1 (perform while system is disarmed and in normal mode)

INITIALIZE DOWNLOAD and RESET DEFAULTS

- *96** Press *96 while in Program Mode. This initializes the system for downloading and resets all the subscriber account numbers and CSID.
- *97** Press *97 while in Program Mode. This resets all data fields to the default values shown on the Program Form. Use *97 only if you wish to return to the original factory-programmed defaults. Do not press *97 to load defaults if any programming has been done previously—data already programmed into the system will be changed!

TO EXIT PROGRAMMING MODE:

- *98** Exits programming mode and *prevents* re-entry by: **Installer Code + 8 + 0 + 0**. If ***98** is used to exit programming mode, system must be powered down, and method A above used to enter the programming mode. See field *88 for other *98 Program mode lockout options.
- *99** Exits programming mode and *allows* re-entry by: **Installer Code + 8 + 0 + 0** or method A above.

SPECIAL MESSAGES

OC = OPEN CIRCUIT (no communication between Keypad and Control).

EE or **ENTRY ERROR** = ERROR (invalid field number entered; re-enter valid field number).

After powering up, **AC**, **dl** (disabled) or **Busy Standby** and **NOT READY** will be displayed after approximately 4 seconds. This will revert to a "**Ready**" message in approximately 1 minute, which allows PIRS, etc. to stabilize. You can bypass this delay by pressing **[#]** + **[0]**.

If **E4** or **E8** appears, more zones than the expansion units can handle have been programmed. The display will clear after you correct the programming.

DATA FIELD PROGRAMMING FORM

Where noted, certain fields have special settings when used with the **VISTA-10PSIA** (indicated by heavy borders and reverse type throughout for easy identification).

SIA Guidelines: Notes in certain data fields give instructions for programming the VISTA-10P for False Alarm Reduction.

NOTE: Entry of a number other than one specified will give unpredictable results. Values shown in brackets are factory defaults.

***20 Installer Code** [4112]

4 digits, 0–9. Can perform all system functions except cannot disarm unless it is used to arm system.

***21 Quick Arm Enable** [0]

0 = no quick arm; 1 = allow quick arm (with [#] key)
Select whether or not users can press the [#] key in place of entering a security code when arming the system (e.g., to arm AWAY, press [#] + AWAY). If not selected, users must enter a security code to arm the system. In either case, the user code is always needed to **disarm** the system.

***22 RF Jam Option** [0]

0 = no RF Jam detection
1 = send RF Jam report upon detection of RF jamming signal
Select whether or not the system sends an RF jam report if an RF jamming signal is detected.

UL: must be 1 if wireless devices are used

***23 Quick (Forced) Bypass** [0]

0 = no quick bypass UL: must be "0"
1 = allow quick bypass (code + [6] + [#])
Select whether or not the Quick Bypass command (code +[6] + [#]) is active. Zones bypassed by this function will be displayed after the bypass is initiated.

***24 RF House ID Code** [00]

00 = disable all wireless keypad usage
01–31 = house ID for 5827, 5827BD or 5804BD keypad
Enter the RF House ID, which identifies receivers and wireless keypads. If a 5827 or 5827BD Wireless Keypad or 5804BD Transmitter is being used, a House ID code **must** be entered, and the keypad set to the same House ID.

***26 Chime By Zone** [0]

0 = no (chimes on fault of **any** entry/exit or perimeter zone when chime mode on);
1 = use zone list (chimes on fault of **specific** zones programmed in chime zone list 3 when Chime mode on; use *81 Menu mode to select zones)
Select if you want a list of specific zones to chime when faulted while the system is in Chime mode (use zone list 3 to assign these zones; see *81 Zone List Programming section for details). If not selected, all entry/exit and perimeter zones will chime when faulted and system is in Chime mode.

***28 Access Code For Phone Module** [00]

00 = disable; UL: must be "00" for UL Commercial Burg. inst.
1st digit: enter 1–9; 2nd digit: enter # + 11 for "*", or # + 12 for "#".
Enter a 2-digit access code for the 4286 Phone Module, if used. Example: If desired access code is 7* , 7 is the first entry, and [#] + 11 (for *) is the second entry.
NOTE: A "0" in either digit disables the phone module.

***29 Enable IP/GSM – Communication Device Menu Mode (pass-through programming)**

This is a Menu Mode command, not a data field.
See *29 Menu Mode section later in this document.

***31 One Audible Alarm Per Zone** [0]

0 = unlimited sounding
1 = one alarm sounding on bell output per zone

VISTA-10PSIA: If "0" selected, "alarm sounding per zone" will be the same as the "number of reports in armed period" set in field *93 (1 if one report, 2 if 2 reports, unlimited for zones in zone list 7).

Select whether or not the system limits alarm sounding to once per arming period for a given zone.

***32 Fire Alarm Sounder Timeout** [0]

0 = sounder stops at timeout programmed in field *33
1 = no sounder timeout UL: must be "1" for fire install.
Select whether or not alarm sounding continues until manually turned off (ignores sounder timeout). If not selected, sounding stops at timeout programmed in *33. This control complies with NFPA requirements for temporal pulse sounding of fire notification appliances. Temporal pulse sounding for a fire alarm consists of the following: 3 pulses – pause – 3 pulses – pause – 3 pulses.

***33 Alarm Sounder (Bell) Timeout** [1]

0 = none; 1 = 4 min; 2 = 8 min; 3 = 12 min; 4 = 16 min
UL: For residential fire alarm installation, must be set for a minimum of 4 min (option 1); for UL Commercial Burglary installations, must be minimum 16 min (option 4)
Enter the desired alarm sounding time. Entering "0" lets sounding continue until manually turned off.

***34 Exit Delay** [60]

00 - 96 = 0 - 96 secs; 97 = 120 secs
SIA Guidelines: minimum exit delay is 45 seconds

VISTA-10PSIA: 45 - 96 = 45 - 96 secs; 97 = 120 secs
NOTE: Entries less than 45 will result in a 45-second delay.

Enter the desired time the system waits before arming entry/exit zones. If the entry/exit door is left open after this time expires, an alarm will occur.
UL installations: For UL Commercial Burglar Alarm and UL Residential Burglar Alarm installations with line security, total exit time must not exceed 60 seconds.

***35 Entry Delay #1 (zone type 01)** [30]

00 - 96 = 0 - 96 secs; 97 = 120 secs; 98 = 180 secs; 99 = 240 secs
SIA Guidelines: minimum entry delay is 30 seconds

VISTA-10PSIA:
30-96 = 30 - 96 secs; 97 = 120 secs; 98 = 180 secs; 99 = 240 secs
NOTE: Entries less than 30 will result in a 30-second delay.

For UL Residential Burglary Alarm installations, must be set for a maximum of 30 seconds; entry delay plus dial delay should not exceed 1 min. For UL Commercial Burglar Alarm, total entry delay may not exceed 45 seconds.

Enter the desired time within which the system must be disarmed after opening an entry door. If this time expires without disarming, an alarm occurs.

***36 Entry Delay #2 (zone type 02)** [30]

See *35 Entry Delay 1 above for entries.
Use this entry for a secondary entry door. See *35 above for explanation.

***37 Audible Exit Warning** [1]

0 = no; 1 = yes; SIA Guidelines: must be enabled (enter 1)

VISTA-10PSIA: Feature always enabled; field does not exist.

Select whether or not you want exit warning sounds, which consist of slow continuous beeps until the last 10 seconds, then it changes to fast beeps. Sound ends when exit time expires.

***38 Confirmation Of Arming Ding** [0]

0 = no ding
 1 = confirmation ding after arming system
 2 = ding after arming from RF button or RF keypad only (except 5827/5827BD)

UL: must be "1" for UL Commercial Burglar Alarm inst.
 Select whether and when you want a confirmation of arming "ding" (1/2 second external sounder "ding").
 If "1" selected, ding occurs when closing report is sent, or at the end of Exit Delay.
 If "2" selected, ding occurs upon reception of the wireless arming command.

***39 Power Up In Previous State** [1]

0 = always power-up in a disarmed state
 1 = assume the system status prior to power down

UL: must be "1" SIA Guidelines: must be enabled (enter 1)

VISTA-10PSIA: Feature must be enabled (enter 1).

Select whether or not the system powers up in its previous state (if the system powers up armed and a zone is faulted, an alarm will occur 1 minute after power up). Note that if the previous state was armed Away or Stay, the system ignores sensor changes for 1 minute, which allows time for sensors such as PIRs to stabilize.

DIALER PROGRAMMING

Enter the number of digits shown. Do not fill unused spaces. Enter 0-9; #+11 for *; #+12 for #; #+13 for a 2-second pause. If fewer than the maximum digits entered, exit the field by pressing [*]. The next field number is displayed.

***40 PABX Access Code**

Enter up to 6 digits. To clear entries, press *40*. If call waiting used, enter its cancel digits * (#+11) 70 plus # + 13 (pause).

NOTES:

1. The call waiting disable feature cannot be used on a PABX line.
2. Using call waiting cancel on a non-call waiting line will prevent successful communication to the central station.

VISTA-10PSIA: If call waiting is used, enter call waiting disable digits as described above, and also set Call Waiting Disable option in field *91.

Enter the PABX code, if used. If fewer than 6 digits, exit by pressing [*], which advances to the next field.

Call Waiting: If the subscriber's phone service has "call waiting" (and is not using PABX), enter **70 ("# + 11") plus # + 13 (pause) as the PABX entry to disable "call waiting" during control panel calls. If the subscriber does not have "call waiting" and is not using PABX, make no entry in this field.

Important: 1. The call waiting disable feature cannot be used on a PABX line. 2. Using Call Waiting Disable on a non-call waiting line will prevent successful communication to the central station.

***41 Primary Phone No.**

***42 Secondary Phone No.**

Enter up to 20 digits. To clear entries, press *41* or *42* respectively.

Enter the primary phone and secondary phone numbers. If you enter fewer than 20 digits, exit by pressing [*]. To clear entries from field, press *41*.

NOTE: Entry of a number other than one specified will give unpredictable results.

For fields *43- *44: Enter 0-9; #+11 for B; #+12 for C; #+13 for D; #+14 for E; #+15 for F. Enter [*] as the fourth digit if a 3-digit account number (for 3+1 dialer reporting format) is used. Enter 0 as the first digit of a 4-digit account number for Nos. 0000-0999. Exit field by pressing * (and press next field number) if only 3 digits are used. E.g., For Acct. B234, enter: #+11, 2, 3, 4

***43 Primary Subs. Acct. No.**

Enter 4 or 10 digits, depending on selection in *48 Report Format. See box above for entries. To clear, press *43*. Enter the primary subscriber account number.

***44 Secondary Subs. Acct. No.**

See *43. To clear, press *44*. Enter the secondary subscriber account number

***47 Phone System Select** [1]

DIALING	NOT On WATS LINE	USING WATS LINE
Pulse Dial	0	2
Tone Dial	1	3

Select whether the system will be using pulse or tone dialing, and whether it is on a WATS line.

***48 Report Format** [77]

0 = 3+1, 4+1 ADEMCO L/S STANDARD Primary Second
 1 = 3+1, 4+1 RADIONICS STANDARD
 2 = 4+2 ADEMCO L/S STANDARD
 3 = 4+2 RADIONICS STANDARD
 5 = 10-digit ADEMCO CONTACT ID® REPORTING
 6 = 4+2 ADEMCO EXPRESS
 7 = 4-digit ADEMCO CONTACT ID® REPORTING
 8 = 3+1, 4+1 ADEMCO L/S EXPANDED
 9 = 3+1, 4+1 RADIONICS EXPANDED

Select the desired type of reports to be sent to the primary/secondary numbers. Make selection from the table in the Programming Guide. If "0" selected, all reports go only to the primary number unless unsuccessful, then control will attempt to dial secondary number.

***49 Split/Dual Reporting** [0]

0 = Standard/Backup reporting only (all to primary unless fail) See Backup Reporting note below.

Primary Phone No.	Secondary Phone No.
1 = Alarms, Restore, Cancel	Others
2 = All except Open/Close, Test	Open/Close, Test
3 = Alarms, Restore, Cancel	All
4 = All except Open/Close, Test	All
5 = All	All

1 = Alarms, Restore, Cancel
 2 = All except Open/Close, Test
 3 = Alarms, Restore, Cancel
 4 = All except Open/Close, Test
 5 = All

Backup Reporting: All reports are sent only to the primary number unless unsuccessful after 8 attempts. If unsuccessful, the system makes up to 8 attempts to send all reports to the secondary number. If still unsuccessful after 16 attempts, the system displays "COMM FAILURE" message (FC for fixed-word keypads). Backup reporting is automatic only if there is a secondary phone number (field *42)

***50 Burglary Dialer Delay** [2, 0]

Delay Time: Delay Time **VISTA-10PSIA**
 0 = no delay **UL: must be "0"** Delay Disable

1 = 15 seconds; 2 = 30 seconds; 3 = 45 seconds
 SIA Guidelines: delay must be minimum of 15 seconds

VISTA-10PSIA:
Delay Time: 1 = 15 secs; 2 = 30 secs; 3 = 45 secs
Delay Disable:
 0 = use delay set in entry 1
 1 = dial delay disabled for zones listed in zone list 6 (use zone list 6 to enter those zones that require dial delay to be disabled; these zones ignore the setting in entry 1)
UL: Dial delay plus entry delay must not exceed one minute; use zone list 6 to disable dial delay from appropriate zones, if necessary.

Enter the desired delay time (none, 15, 30, or 45 seconds) before a "BURGLARY ALARM" report is sent to the central station. This delay allows time for the subscriber to avoid sending a false alarm if the alarm was inadvertently caused. This delay does not apply to zone type 24 alarms (silent burglary) or to 24-hour zone types 6, 7, and 8 (silent panic, audible alarm, auxiliary alarm), which are always sent as soon as they occur.

***53 SESCOA/Radionics Select** [0]
 0 = Radionics (0-9, B-F), and all formats other than SESCOA
 1 = SESCOA (0-9 only reporting)
 Select whether SESCOA format is used.

***54 Dynamic Signaling Delay** [0]
 Delay selectable from 0 to 225 secs in 15-sec increments.
 0 = no delay (both signals sent); 1 = 15 secs; 2 = 30 secs, etc
UL: If using line security, must be 0.
 Intended for use with communication device on ECP (ex. LRR) reporting. Enter the desired time the panel should wait, per message, for acknowledgment from the first reporting destination (see *55) before it attempts to send a message to the second destination. Entering "0" sends redundant reports to both Primary Dialer and the communication device.

***55 Dynamic Signaling Priority** [0]
 0 = Primary Dialer first; 1 = Communication Device first.
For UL Commercial Burglary installations that use a DACT and LRR, this field must be "0".

Intended for use with communication device reporting (field *29 must be enabled).
 Select the initial reporting destination for messages as follows:
 Primary Dialer First selected (0):
 • If acknowledged before delay expires (see *54), then message will not be sent via communication device.
 • If not acknowledged before delay expires, message is sent to both the Primary Phone No. and communication device.
 Communication Device (LRR) First selected (1):
 • If acknowledged before delay expires, then message will not be sent to the primary dialer.
 • If not acknowledged before delay expires, then message is sent to both Primary Phone No. and communication device.

***56 - *58 Menu Modes**
 These are Menu Mode commands, not data fields.
 See Menu Mode sections later in this document.

PROGRAMMING SYSTEM STATUS, & RESTORE REPORT CODES (*59 - *68, *70 - *76, and *89):
For 3+1 or 4+1 Standard Format: Enter a code in the *first* box: 1-9, #+10 for 0, #+11 for B, #+12 for C, #+13 for D, #+14 for E, #+15 for F.
 A 0 (*not* #+10) in the *first* box will disable a report. A 0 (*not* #+10) in the *second* box will result in automatic advance to the next field.
For Expanded or 4+2 Format: Enter codes in *both* boxes (1st and 2nd digits) for 1-9, 0, or B-F, as described above.
 A 0 (*not* #+10) in the *second* box will eliminate the expanded message for that report. A 0 (*not* #+10) in *both* boxes will disable the report.
For Ademco Contact ID® Reporting: Enter any digit (other than 0) in the *first* box, to enable zone to report (entries in the *second* boxes are ignored).
 A 0 (*not* #+10) in the *first* box disables the report.
 UL installations: Program fields *59 - *76 as required by applicable UL Standards shown in each field.

SYSTEM STATUS REPORT CODES

***59 Exit Error Report Code** [0]
 See box above for entries.
VISTA-10PSIA: [1] Always enabled.
 After arming the system, entry/exit and interior zones remaining open after exit delay expires cause an alarm sound at the keypad and external sounder (keypad also displays "EXIT ALARM"), and entry delay begins. Disarming before the end of the entry delay stops alarm sounding and no message is sent to the central station. The keypad displays "CA" (fixed-word) or "ALARM CANCELED" (alpha display).
 *59 continued in next column

***59 Exit Error Report Code (continued)**
 If the system is not disarmed before entry delay expires, an "EXIT ALARM" message (**VISTA-10PSIA:** also zone alarm message) will be sent to the central station if Exit Error Report Code is enabled. The keypad will display "EA" (fixed-word) or "EXIT ALARM" (alpha display), and alarm sounding continues until the system is disarmed (or timeout occurs).

An Exit Alarm condition will also result if a fault occurs in an exit or interior zone within 2 minutes following the end of the exit delay, and an "EXIT ALARM" message will be sent to the central station (except for **VISTA-10PSIA**, see field *69 Recent Closing report).

***60 Trouble Report Code** [10]
 Sent if a zone has a trouble condition.
 UL: Required for UL commercial burglar alarm installations and for residential fire alarm installations

***61 Bypass Report Code** [00]
 Sent when a zone is manually bypassed.
 UL: Required for UL commercial burglar alarm installations.

***62 AC Loss Report Code** [10]
 Enter the appropriate report code. Timing of this report is random with up to a 4-hour delay. If AC restores before the report goes out, there is no "AC LOSS" report.
 UL: Required for UL commercial burglar alarm installations and for residential fire alarm installations

***63 Low Bat Report Code** [10]
 Sent when a low-battery condition exists in the system's battery.
 UL: Required for UL commercial burglar alarm installations and for residential fire alarm installations

***64 Test Report Code** [00]
 Sent periodically to test that the communicator and phone lines are operational
 Use Scheduling mode to set periodic test reports or use the following key commands to set schedule 2 to the stated repeat option (first test report sent 12 hours after command):
 installer code +[#] + [0] + 0 = test report sent every 24 hours
 installer code +[#] + [0] + 1 = test report sent once per week
 installer code +[#] + [0] + 2 = test report sent every 28 days
 Each mode sets schedule 2 to the selected repeat option; first test report sent 12 hours after command.
 NOTE: Make sure the Real-Time Clock is set to the proper time before entering the test report schedule command to ensure that test reports are sent when expected. (see Setting the Real-Time Clock section).
 UL: Required for UL commercial burglar alarm installations and for residential fire alarm installations

***65 Open Report Code** [0]
 Enter the appropriate report code, which is sent upon disarming of the system.
 UL: Required for UL commercial burglar alarm installations

***66 Arm Away/Stay Rpt Code** [0,0]
 Enter appropriate report code. Away Stay
 NOTE: "OPEN" reports not sent if associated closing report is not enabled

***67 RF Trans. Low Bat Report Code** [00]
 Sent when a wireless transmitter low-battery condition exists.
 UL: must be enabled if wireless devices are used.

***68 Cancel Report Code** [00]
VISTA-10PSIA: [10] Report enabled.
 Sent upon disarming of the system after an alarm was reported.

***69 Recent Closing Report Code** [11]

VISTA-10PSIA: Always enabled. Field does not apply to other controls.

Similar to the Exit Error condition described in field *59, but occurs if any burglary zone is faulted within two minutes after the initial exit delay expires. Disarming the system within the two minutes stops the alarm sound and displays "ALARM CANCELED" or "CA" and the faulted zone number. No message is sent to the Central Monitoring Station.

If the system is not disarmed within two minutes, the alarm sound continues and a "recent closing" and a "zone alarm" message are sent to the Central Monitoring Station (after dial delay expires).

RESTORE REPORT CODES

***70 Alarm Restore Rpt Code** [0]

Sent when an alarm zone is restored to its non-faulted condition.

UL: Required for UL commercial burglar alarm installations and for residential fire alarm installations

***71 Trouble Restore Rpt Code** [00]

Sent when a trouble in a zone is restored and code + OFF performed.

UL: Required for UL commercial burglar alarm installations.

***72 Bypass Restore Rpt Code** [00]

Sent when a zone that has been bypassed is unbypassed.

UL: Required for UL commercial burglar alarm installations

***73 AC Restore Rpt Code** [00]

Sent after AC power has been restored after an AC power outage.

UL: Required for UL commercial burglar alarm installations and for residential fire alarm installation

***74 Low Bat Restore Rpt Code** [00]

Sent after a system low-battery condition is restored to normal.

UL: Required for UL commercial burglar alarm installations and for residential fire alarm installations

***75 RF Trans. Lo Bat Rst Rpt Code** [00]

Sent when a trans. low battery is restored (new battery installed).

UL installations: must be enabled if wireless devices are used. Required for UL commercial burglar alarm installations and required for residential fire alarm installations.

***76 Test Restore Rpt Code** [00]

Sent when the Test mode is exited or upon timeout (4 hrs).

UL: Required for UL commercial burglar alarm installations and for residential fire alarm installations

OUTPUT AND SYSTEM SETUP

***77 Daylight Savings Time** [3][11]

Start/End Month

0 = Disabled; 1-9 = January-September (1 = Jan, 2 = Feb, etc) #+10 = October; #+11 = November; #+12 = December

Enter the start and end month for daylight savings time, if applicable to the region.

***78 Daylight Savings Time** [2][1]

Start/End Weekend

0 = disabled, 1 = first, 2 = second, 3 = third 4 = fourth, 5 = last, 6 = next to last, 7 = third to last

Enter the start and end weekend for daylight savings time, if applicable to the region.

***79 - *82 Menu Modes**

These are Menu Mode commands, not data fields. See Menu Mode sections later in this document.

***84 Auto Stay Arm** [1]

0 = no, 1 = yes, auto stay arm enabled

If enabled, the system will automatically change AWAY mode to STAY mode if the entry/exit door is not opened and closed within the exit delay time after a user arms in AWAY mode from a wired keypad (non-RF device). An Opening report followed by an Armed Stay report is sent to the Central Station.

If the door is opened and closed within the exit delay period, the system remains in AWAY mode.

Any RF device that arms the system AWAY overrides this feature and the system remains armed AWAY

***85 Cross Zone Timer** [0]

This option not for use in UL installations.

0 = 15 seconds	6 = 2-1/2 min	#+12 = 8 min
1 = 30 seconds	7 = 3 min	#+13 = 10 min
2 = 45 seconds	8 = 4 min	#+14 = 12 min
3 = 60 seconds	9 = 5 min	#+15 = 15 min
4 = 90 seconds	#+10 = 6 min	
5 = 2 minutes	#+11 = 7 min	

Assign cross zones on zone list 4, with *81 Menu mode.

NOTE: Cross zoning takes effect only after Exit Delay expires.

Select the maximum amount of time in which two cross zones must be tripped in an armed system to send an alarm message to the Central Station. If only one cross zone is tripped during this time, a trouble message (CID code 380) for that zone is sent to the Central Station.

***86 Cancel Verify Keypad Display** [1]

0 = no, 1 = yes

Select whether "ALARM CANCELED" is displayed on the LCD keypad under the following conditions:

- After the kissoff of the cancel message to the Central Station, indicating a successful transmission.
- When an alarm is successfully canceled before the Central Station received the Alarm message. E.g., if an alarm is incorrectly triggered and the user presses code + OFF before the dial delay time has expired, the message will never go out to the CS.
- When the Cancel report is not enabled and the system is disarmed:
 - a. before dialer delay expires (alarm report not sent) message "Alarm Canceled" is displayed.
 - b. after dialer delay expires message "Alarm Canceled" is not displayed.

***87 Misc. Fault Delay Time** [0]

(used with Configurable Zone Type "digit 6")

0 = 15 seconds	6 = 2-1/2 min	#+12 = 8 min
1 = 30 seconds	7 = 3 min	#+13 = 10 min
2 = 45 seconds	8 = 4 min	#+14 = 12 min
3 = 60 seconds	9 = 5 min	#+15 = 15 min
4 = 90 seconds	#+10 = 6 min	
5 = 2 minutes	#+11 = 7 min	

UL: may only be used on non-burglar alarm/ non-fire alarm zones when used in fire and/or UL burglar alarm installation

Enter the desired fault delay time. Used with zones assigned to a configurable zone type with fault delay on (configurable zone type digit "6"), and sets a zone response time of 15 seconds to 15 min. It can be assigned to zones with sensors that provide a trouble indication when an oil tank is low, or similar applications for critical condition monitoring where a non-alarm response is desired.

***88 Program Mode Lockout Options** [0]

0 = standard *98 installer code lockout

(reentry only by [*] + [#] within 50 seconds after power up)

1 = lockout [*] + [#] reentry after *98 exit

2 = not used

3 = lockout local programming after *98 exit (reentry by downloader only)

***89 Event Log Full Report Code** [00]

See box above *59 for report code entries. Sent when the event log is 80% full (if an event log enable is made in field *90). If the log becomes full, new messages overwrite the oldest messages in the log.

***90 Event Log Enables** [3]

NOTE: System messages are logged when any non-zero entry is made.
 0 = None
 1 = Alarm/Alarm Restore
 2 = Trouble/Trouble Restore
 4 = Bypass/Bypass Restore; 8 = Open/Close.
 Example: To select "Alarm/Alarm Restore", and "Open/Close", enter 9 (1 + 8); to select all, enter #15. Select the types of events (up to 32 events) the system should log. The downloader operator can then upload the log and view or print out all or selected categories of the log. The downloader operator can also clear the log. The Event log can also be viewed at an alpha keypad. The display/printout at the central station will show the date, time, event, and description of occurrences

***91 Option Selection** [8, 0]

Options: 0 = None Options **VISTA-10PSIA**
 1 = Bell Supervision Processing Call Wait Disable
NOTE: If Bell Supervision is selected, you must also cut the red PCB Bell Supervision jumper.
 4 = AAV **UL: must use ADEMCO UVCN module**
 8 = Exit Delay Restart/Reset **UL: must be disabled**
 #+12 = AAV and Exit Delay Restart/Reset
 SIA Guidelines: Exit Delay should be enabled.

VISTA-10PSIA: Options: Same as listed above.

Call Waiting Disable:

- 0 = call waiting not used
- 1 = call waiting disable digits (*70) entered in field *40; (when selected, the system dials the entry in field *40 only on alternate dial attempts; this allows proper dialing in the event call waiting service is later canceled by the user).

Select the desired options by adding the values of each desired option.
 "Exit Delay Restart/reset" option allows use of the [*] key to restart the exit delay at any time when the system is armed STAY or INSTANT. This feature also enables automatic exit delay reset, which resets exit delay if the entry/exit door is re-opened and closed before exit delay time expires after arming AWAY. Automatic Exit Delay Reset occurs **only once** during an armed AWAY period.
IMPORTANT: AAV should not be used when Paging or Alarm Reports are sent to a secondary number unless the monitoring zone option is used (which pauses calls). Otherwise, the call to the secondary number by the communicator after the alarm report will prevent the AAV from taking control of the telephone line, and the AAV "Listen in" session cannot take place.

***93 Reports In Armed Period** [1,0]

Per Zone (Swinger Suppression) Restrict **VISTA-10PSIA**
Restrict Report Pairs: Report Pairs Unlimited
 0 = Unlimited Reports Reports Enable
 1 = 1 report pair
 2 = 2 report pairs SIA Guidelines: Must be set for 1 or 2.

VISTA-10PSIA:

Restrict Report Pairs: 1 = 1 report pair; 2 = 2 report pairs
Unlimited Reports Enable:
 0 = restrict reports to the setting in entry 1
 1 = unlimited reports for zones listed in zone list 7; (use zone list 7 to enter those zones that require unlimited reporting; these zones ignore the setting in entry 1)

Select the number (0, 1, or 2) of alarm/alarm restore message pairs per zone allowed to be sent to the central station in an armed period. Applies to burglary zones only.

DOWNLOAD INFORMATION

***94 Download Phone No.**

Enter up to 20 digits, 0-9; #+11 for '*'; #+12 for '#'; #+13 for a 2-second pause. Do not fill unused spaces. If fewer than 20 digits, exit field by pressing *. To clear entries, press *94*.

UL: downloading may be performed only if a technician is at the site.

Enter the downloading computer phone number.

***95 Ring Count For Downloading** [15]

NOTE: Do not enter "0" if using 4286 Phone Module.
 0 = Disable Station Initiated Download;
 1-14 = number of rings (1-9, # +10 =10, # +11 =11, # +12 =12, # +13 =13, # +14 =14);
 15 = answering machine defeat (# +15 =15).
 Refer to the chart below and program this field accordingly.

phone module	answer machine	down-loading	Set field *95 to...
yes	no	no	1-14 (not 0)
yes	yes	no	higher than number of rings set on answer machine (e.g., if ans. machine is 4 rings, set this field to 5). This allows access to the phone module if the answer machine is turned off.
yes	no	yes	1-14 (not 0)
yes	yes	yes	15 (bypasses answer machine†)
no	no	no	0
no	yes	no	0
no	no	yes	1-14
no	yes	yes	15

† **NOTE:** If "15" is entered to bypass an answering machine, and a 4286 Phone Module is included in the system, note the following: When calling in from an off-premises phone, the user should make the initial call, allow 1 or 2 rings only, then hang up, then call again. The phone module will now seize the line, and 2 long tones sound, followed by the usual voice prompt for the access code. If this procedure is not followed, phone module operation will not be possible.

***96, *97 Initialize/Reset Defaults**
 (These are commands, not data fields.)

***98, *99 Exit Commands**
 (These are commands, not data fields.)

PAGER OPTIONS

The system can send various reports to a pager. To program pager reporting, do the following:
 1. Enter the appropriate information in the Pager data fields that follow.
 2. Enable Pager Delay, if desired, in field *172
 3. Make sure appropriate user open/close pager reports are enabled using the user attribute command.
 4. If using latchkey pager report, define the latchkey report schedule using Scheduling mode (master code + [#] [6] [4] then select event type "03"). System must be armed for the Latchkey report to be sent.
 5. If using a function key to manually send a message to a pager, see Function Keys section to program the appropriate function.
 6. If reporting zone alarms and troubles to a pager, use *81 Zone List menu mode to assign the zones associated with each pager (zone lists 9).

***160 Pager 1 Phone No.**

Enter up to 20 digits. 0-9; #+11 = '*'; #+12 = '#'; #+13 = 2-sec pause.

Enter the pager phone number. If you enter fewer than 20 digits, exit by pressing [*] and next field number. To clear entries from this field, press *160*

***161 Pager 1 Characters**

--	--	--	--	--	--	--	--	--	--	--	--	--	--	--	--

Enter the optional prefix characters, up to 16 digits.
 0-9; #+11 = '*'; #+12 = '#'; #+13 = 2-second pause.

Enter up to 16 optional characters, which may be sent as a prefix to the 7-digit system status code sent to Pager 1 (if used). Phone number in field *160 must be entered. If fewer than 16 characters, exit by pressing [*] and next field number. To clear entries from this field, press *161*. For example, these optional 16 characters may be composed of the following:

- paging company PIN number, subscriber account number, * (enter # + 11 to send *), # (enter # + 12 to send #), pause (enter # + 13 to allow a 2-second pause; some paging systems require pause)
- Any special character(s) the end user may decide to transmit

The format for the 7-digit system status code is defined as follows:

Pager Format: XXX-YYYY where:

XXX = 3-digit event code: 911 = Alarm
 811 = Trouble
 101 = Opening (disarm)
 102 = Closing (arm AWAY)

YYYY = 4-digit user or zone number (depending on type of event).

The first digit is "1," followed by the 3-digit user or zone number, or "0," followed by a 3-digit device address number.

Example 1. Pager displays: 9 1 1 - 1 0 0 4 : an alarm (911) caused by a fault in zone 4 (1004).

Example 2. Pager displays: 1 0 2 - 1 0 0 5 : a closing-system arming (102) by User 5 (1005).

***162 Pager 1 Report Options**

[0]

- 0 = no reports sent
- 1 = Opens/closes all users
- 4 = All alarms and troubles
- 5 = All alarms / troubles, and opens/closes for all users
- 12 = Alarms / troubles for zones entered in zone list 9
- 13 = Alarms / troubles for zones entered in zone list 9, and opens/closes for all users

Enter the types of reports to be sent to the pager. Open/close reports go to pager only when arming (close)/disarming (open) from a keypad using a security code; auto-arming/disarming, arming with assigned button, and keyswitch arming do not send pager messages.

***172 Pager Delay Option For Alarms**

[3]

0 = none, 1 = 1 minute, 2 = 2 minutes, 3 = 3 minutes
 Enter the desired pager delay for alarms.

MISCELLANEOUS SYSTEM FIELDS

***177 Device Duration 1, 2**

[0] [0]

(used in *80 Menu mode-Device Actions 5/6)

0 = 15 seconds	6 = 2-1/2 min	#+11 = 7 min
1 = 30 seconds	7 = 3 min	#+12 = 8 min
2 = 45 seconds	8 = 4 min	#+13 = 10 min
3 = 60 seconds	9 = 5 min	#+14 = 12 min
4 = 90 seconds	#+10 = 6 min	#+15 = 15 min
5 = 2 minutes		

Enter the desired duration for output action options 5 (duration 1) and 6 (duration 2) programmed in *80 Output Function Programming.

***181 60 Hertz AC Operation**

[0]

0 = 60 Hz; 1 = 50 Hz
 Select the type of AC power applied to the control (option is used for Real-Time Clock synchronization).

CONFIGURABLE ZONE TYPE OPTIONS

The system allows you to define a custom zone type, based on the options described below. This configurable zone types can be programmed via the downloader or from a keypad using data fields *182-*183 described below.

Configurable Zone Type Options	
Auto Restore (entry 2)	Faults on zones set for this option are cleared; restore messages sent upon restoral of faults.
Vent Zone (entry 2)	Zones set for this option are ignored if faulted when arming the system, but are protected if the zone is later restored (e.g., an open window can be ignored when arming, but if the window is later closed, it will be protected; opening the window again causes an alarm.)
Bypass Disarmed (entry 4)	Zones set for this option can be bypassed only while the system is disarmed.
Bypass Armed (entry 4)	Zones set for this option can be bypassed when the system is armed.
Dial Delay (entry 6)	Alarms on zones set for this option participate in dial delay central station reporting, if system dial delay enabled in field *50.
Fault Delay (entry 6)	Faults on zones set for this option are delayed by the time set in field *87. Do not use this option if using entry/exit delay for this zone type.
Faults Display (entry 7)	Selects how faults on zones set for this zone type are displayed.
Power Reset/Verification (entry 7)	Selects whether the system resets power (when user enters code + OFF), and whether the system performs alarm verification when a fault occurs on these zones.
Use Entry Delay (entry 8)	Selects whether to use the system's entry delay times.
Use Exit Delay (entry 8)	Selects whether to use the system's exit delay time.
Interior Type (entry 8)	Zones set for this option are treated same as standard zone type 4 (bypasses when armed STAY, faults displayed).
Alarm Sounds (entry 9)	Selects the type of alarms sound for zones set for this zone type.
Bell Timeout (entry 9)	Alarm sounding on zones set for this option remain for the duration set in fields *32/*33.
Fire Zone (entry 9)	Zones set for this option respond in the same manner as if programmed for zone type 9. Do not set fire zones to respond as a "fault" in entries 1-6.
Trouble Sounds (entry 10)	Selects the type of trouble sounds for zones set for this zone type (periodic beeps = once every 30 seconds; trouble beeps = rapid beeping).
Chime Enable (entry 10)	Zones set for this option cause a chime when Chime mode is on.

***182 Configurable Zone Type 90**

<input type="checkbox"/>	<input type="checkbox"/>	<input type="checkbox"/>	<input type="checkbox"/>	<input type="checkbox"/>	<input type="checkbox"/>	<input type="checkbox"/>	<input type="checkbox"/>	<input type="checkbox"/>	<input type="checkbox"/>
1	2	3	4	5	6	7	8	9	10

(0-9, #+10=10, #+11=11, #+12=12, #+13=13, #+14=14, #+15=15).

UL: Do not configure zones as a fire alarm or UL burglar alarm zone.

Enter the appropriate value for each entry, 1-10, based on the charts provided on the next page. Each entry is the sum of the values of its selected options

To calculate the value for each entry, add the values of the selected options in each of the entry's columns shown in the respective chart (one option per column). For example, to program entry 2 for "alarm response to short," "auto restore on," but not a "vent zone," enter 5 ("1" for alarm short + "4" for auto restore-yes + "0" for vent zone-no).

IMPORTANT: Be careful when selecting combinations of options for configurable zone types. Contradictory options can cause unpredictable results.

***183 Zone Type 90 Report Codes**

IMPORTANT: Use existing Contact ID® codes, if appropriate, or define unique codes in CID code range 750-789. See note in installation instructions.

90 ALARM ID: XXX
TROUBLE ID: XXX

Enter the desired 3-digit Contact ID® report codes for alarms and troubles occurring on zones assigned to this zone type. Enter the codes sequentially (all 6 digits). When entering digits, [#] moves cursor back, [*] moves forward. Press [*] when done to continue.

NOTE: Zone alarm report codes and trouble report code (*60) and relevant restore codes must be enabled in order to report configurable zone type codes.

KEYPAD OPTIONS

To enable keypads:

1. Set desired address at keypad (refer to keypad's instructions for setting the address). Keypads are identified by predefined addresses (starting at address 16). Options for keypad 1, address 16, are set by the factory and cannot be changed.
2. Use data field program mode to enable keypad addresses and enable sound options in fields *190-*196 as shown in the table above.
3. Set the following keypad-related data fields as required by the installation: *21 Quick Arm Enable
*23 Forced Bypass
*84 Auto STAY Arm

NOTE: Each keypad must be assigned a unique address. Keypads programmed with the same address will give unpredictable results.

***190 Keypad 2 Device Address 17** [0] [0]

Enable: 0 = disabled; 1 = enabled Enable Sound
Sound: 0 = no suppression
1 = suppress arm/disarm and E/E beeps
2 = Suppress chime beeps only
3 = suppress arm/disarm, E/E, and chime beeps
Select whether or not a keypad is used, and enter the desired sound option for the keypad.

***191 Keypad 3 Device Address 18** [0] [0]

***192 Keypad 4 Device Address 19** [0] [0]

***193 Keypad 5 Device Address 20** [0] [0]

***194 Keypad 6 Device Address 21** [0] [0]

***195 Keypad 7 Device Address 22** [0] [0]

***196 Keypad 8 Device Address 23** [0] [0]

***197 Exit Time Display Interval** [0]

0 = no display; 1-5 = seconds between display refresh
Select whether or not keypads display the exit time remaining after arming the system, with display updates at the interval selected (i.e. if the exit delay is 30 seconds and "2" is selected in this field, the keypad display refreshes every 2 seconds, displaying 30, 28, 26, 24, etc.). An interval greater than "1" may be necessary for some older keypads to allow users time to enter key presses between display updates.

FIXED-WORD KEYPAD NOTE: If using 2-digit display keypads (e.g. 6150RF), do not use exit times greater than the 96-second delay option. Using a longer delay time may cause end-user confusion because 2-digit display keypads cannot display times greater than "99." If longer exit time is required by the installation, it is recommended that the Exit Time Display option be disabled ("0").

***199 ECP Fail Display** [0]

0 = 3-digit display ("1" + device address)
1 = 2-digit fixed-display as "91"
Select the 2-digit or 3-digit ECP Fail display, based on the type of keypads being used. The 3-digit display option displays ECP faults as "1" plus the device address (00-30) of the device causing the fault (e.g., faults on device 07 display as "107"), and is intended for Alpha keypads and/or 3-digit Fixed-Word Display keypads. The 2-digit Fixed-Word Display displays ECP faults for all devices as "91" on 2-digit displays, and "191" on 3-digit or Alpha keypads. It is intended for 2-digit display keypads (e.g., certain 6128 series keypads)

CONFIGURABLE ZONE TYPES WORKSHEETS

Configurable zone type 90 can be programmed via downloader software or from a keypad using data fields *182-*183.

Programming Configurable Zone Type options involves making 10 entries in data field *182, where each entry represents the sum of the values of the various options shown in the tables below. Use field *183 to program a Contact ID report code for this zone type.

ENTRY 1 (See note 4 for RF zones)			ENTRY 2 (See note 4 for RF zones)	
Response when system disarmed and zone is:			Auto Restore	Vent Zone
Intact EOL RF zone normal	Open RF zone N/A	Shorted RF zn off-normal		
0 = normal 1 = alarm 2 = trouble 3 = fault	0 = normal 4 = alarm 8 = trouble 12 = fault	0 = normal 1 = alarm 2 = trouble 3 = fault	0 = no 4 = yes	0 = no 8 = yes
Entry 1 = EOL + Open			Entry 2 = Short + auto restore + vent zone	

ENTRY 3 (See note 4 for RF zones)			ENTRY 4 (See note 4 for RF zones)	
Response when armed STAY and zone is:			Byp. when disarmed	Byp. when armed
Intact EOL RF zone normal	Open RF zone N/A	Shorted RF zn off-normal		
0 = normal 1 = alarm 2 = trouble 3 = fault	0 = normal 4 = alarm 8 = trouble 12 = fault	0 = normal 1 = alarm 2 = trouble 3 = fault	0 = no 4 = yes	0 = no 8 = yes
Entry 3 = EOL + Open			Entry 4 = Short + byp. disarmed + byp. armed	

ENTRY 5 (See note 4 for RF zones)			ENTRY 6 (See note 4 for RF zones)	
Response when armed AWAY and zone is:			Dial Delay (see field *50)	Fault Delay (see field *87)
Intact EOL RF zone normal	Open RF zone N/A	Shorted RF zn off-normal		
0 = normal 1 = alarm 2 = trouble 3 = fault	0 = normal 4 = alarm 8 = trouble 12 = fault	0 = normal 1 = alarm 2 = trouble 3 = fault	0 = no 4 = use delay	0 = no 8 = use delay see note 1
Entry 5 = EOL + Open			Entry 6 = Short + dial delay + fault delay	

ENTRY 7		ENTRY 8		
Display Faults	Power Reset/ Verification	Use Entry Delay 1/2	Use Exit Delay	Respond as Interior Type
0 = show alarms when armed & disarmed 1 = don't show alarms when armed (show alarms, trbles, faults when disarmed) 3 = never show any alarms, trbles, faults	0 = no 4 = power reset after fault (by code + OFF) 12 = verification (see zone type 16)	0 = no 1 = delay 1 2 = delay 2	0 = no 4 = use exit delay	0 = no 8 = yes see note 2
Entry 7 = fault display + power reset/verification		Entry 8 = entry delay 1/entry delay 2 + exit delay + interior zone type		

ENTRY 9			ENTRY 10	
Alarm Sounds	Use Bell Timeout	Respond as Fire Zone	Trouble Sounds	Chime when Chime Mode On
0 = none 1 = steady keypad 2 = steady bell and keypad 3 = pulsing bell and keypad	0 = no 4 = yes see fields *32, *33	0 = no 8 = yes see zone type 09; see note 4	0 = none 1 = periodic beep 2 = trouble beeps	0 = no 4 = yes
Entry 9 = alarm sounds + bell timeout + fire zone			Entry 10 = trouble sounds + chime	

Entries for Fields *182	
Entry	Zone Type 90 (field *182)
1	
2	
3	
4	
5	
6	
7	
8	
9	
10	

To calculate the value for each entry:
Simply add the values of the selected options in each of the entry's columns (one option per column). For example, to program Entry 2 for "alarm response to short," "auto restore on," but not a "vent zone," enter 5 ("1" for alarm short + "4" for auto restore yes + "0" for vent zone no).

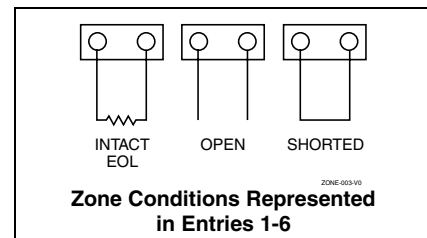

NOTES:

- Do not use the "fault delay" option with a configurable zone type if it is set for an entry or exit delay, otherwise unpredictable results may occur.
- To create an interior type zone, select "respond as interior zone type" (entry 8, interior type = yes), and set zone response to "fault" in entries 3-4 to ensure fault displays; do not set as "normal," "alarm," or "trouble."
- Do not set fire zones to respond as a "fault" (entries 1-6), otherwise faults will not display unless the [*] key is pressed.
- RF Zones: The "open" option in entries 1, 3, and 5 is not applicable for RF zones. Use the "intact EOL" option for normal RF zone conditions and "shorted" for off-normal RF zone conditions.

*56 ZONE PROGRAMMING MENU MODE

(press *56 while in Program mode)

Use *56 Zone Programming to program zones, zone types, report codes, enroll 5800 RF Wireless Transmitter serial numbers, and identify the type of loop input device(s). This mode can also be used to enter alpha descriptors for programmed zones; however, we recommend entering descriptors in menu mode *82 (*Alpha Descriptor Programming*) after all zone programming has been completed.

*58 Expert Programming Mode offers a faster method of zone programming for those who have had previous experience in programming control panels of this type.

<p>SET TO CONFIRM? 0 = NO 1 = YES</p>	<p>We recommend that you select "yes" to confirm the programming of every transmitter. If selected, a prompt appears after entering the serial and loop numbers to confirm each transmitter)</p>																								
<p>Enter Zn Num. (00 = Quit) 10</p>	<p>Enter the zone number being programmed: 01-06 = wired zones; 09-24 = wireless zones; 49-56 = button zones 91 = addr. device report enable (Enter a report code for zone 91 to enable addressable device reporting. 92 = duress report enable (Enter a report code for zone 92 to enable duress reporting) 95, 96, 99 =emergency zones 00 to quit; [*] to continue</p>																								
<p>Zn ZT P RC In: L 10 00 1 10 RF: 1</p>	<p>Summary Screen for the selected zone is displayed. "IN: L" = input type and loop; "HW: RT" = basic wired zone configuration (EOL, NO, NC) and response time [*] to continue</p>																								
<p>10 Zone Type Perimeter 03</p>	<p>Each zone must be assigned to a zone type (list below), which defines the way in which the system responds to faults in that zone. Enter the desired zone type from the list below. If 00 is entered, Delete Zone ? is displayed.</p> <table border="0"> <tr> <td>00 = Not used</td> <td>07 = 24-Hr Audible</td> <td>20 = Arm-STAY*</td> </tr> <tr> <td>01 = Entry/exit #1</td> <td>08 = 24-Hr Aux</td> <td>21 = Arm-AWAY*</td> </tr> <tr> <td>02 = Entry/exit #2</td> <td>09 = Fire</td> <td>22 = Disarm*</td> </tr> <tr> <td>03 = Perimeter</td> <td>10 = Interior w/Delay</td> <td>23 = No Alarm Resp*</td> </tr> <tr> <td>04 = Interior Follower</td> <td>12 = Monitor Zone</td> <td>24 = Silent Burglary</td> </tr> <tr> <td>05 = Trouble Day/Alarm Night</td> <td>14 = Carbon Monoxide</td> <td>77 = Keyswitch</td> </tr> <tr> <td>06 = 24-Hr Silent</td> <td>16 = Fire w/Verify</td> <td>81 = AAV Monitor Zone</td> </tr> <tr> <td colspan="2">*5800 button-type transmitters only</td> <td>90 = Configurable</td> </tr> </table>	00 = Not used	07 = 24-Hr Audible	20 = Arm-STAY*	01 = Entry/exit #1	08 = 24-Hr Aux	21 = Arm-AWAY*	02 = Entry/exit #2	09 = Fire	22 = Disarm*	03 = Perimeter	10 = Interior w/Delay	23 = No Alarm Resp*	04 = Interior Follower	12 = Monitor Zone	24 = Silent Burglary	05 = Trouble Day/Alarm Night	14 = Carbon Monoxide	77 = Keyswitch	06 = 24-Hr Silent	16 = Fire w/Verify	81 = AAV Monitor Zone	*5800 button-type transmitters only		90 = Configurable
00 = Not used	07 = 24-Hr Audible	20 = Arm-STAY*																							
01 = Entry/exit #1	08 = 24-Hr Aux	21 = Arm-AWAY*																							
02 = Entry/exit #2	09 = Fire	22 = Disarm*																							
03 = Perimeter	10 = Interior w/Delay	23 = No Alarm Resp*																							
04 = Interior Follower	12 = Monitor Zone	24 = Silent Burglary																							
05 = Trouble Day/Alarm Night	14 = Carbon Monoxide	77 = Keyswitch																							
06 = 24-Hr Silent	16 = Fire w/Verify	81 = AAV Monitor Zone																							
*5800 button-type transmitters only		90 = Configurable																							
<p>10 Report Code 1st 01 2nd 00 10</p>	<p>Enter the report code for this zone, which consists of 2 hexadecimal digits, each in turn consisting of two numerical digits. For example, for a report code of "10," enter 01 and 00. For Contact ID®, entering any non-zero entry as the first digit enables the report code for this zone. 1-9, 10 for 0, 11 for B, 12 for C, 13 for D, 14 for E, 15 for F 00 to disable; [*] to continue</p>																								
<p>02 HARDWIRE TYPE EOL 0</p>	<p>This prompt appears only for zone numbers 01-06. Enter the desired hardwire type: 0 = EOL; 1 = NC; 2 = NO [*] to continue</p>																								
<p>02 Response Time 1</p>	<p>This prompt appears only for hard-wired zones 01-06 (zone 02 is used as an example in display). Enter the desired response time for this zone: 0 = 10mSec; 1 = 350mSec; 2 = 700mSec; 3 = 1.2 seconds [*] to continue</p>																								
<p>10 INPUT TYPE RF TRANS 3</p>	<p>This prompt is skipped for zones 1-6. All of the RF transmitters have one or more unique factory-assigned input loops (ID codes). Each of the input loops requires its own programming zone (e.g., a 5804's four button inputs require four programming zones). Select the desired input type for the transmitter zone being programmed (some transmitters have more than one input loop, each requiring its own zone; e.g., a 5804's four inputs requires four zones). 3 = RF (supervised RF transmitter; sends fault, restore, and low-battery signals, and sends periodic check-in signals; transmitter must stay within receiver's range) 4 = UR (unsupervised RF transmitter; sends fault, restore, and low-battery signals, but does not send periodic check-in signals; transmitter may be carried off-premises) 5 = BR (unsupervised button type RF transmitter; sends fault and low battery signals when activated, does not send restore or check-in signals; transmitter may be carried off-premises) [*] to continue</p>																								
<p>NOTES: • For basic wired zones, the Input Device type is automatically displayed as HW and cannot be edited.</p>																									
<p>10 INPUT S/N: L A022-4064 1</p>	<p>For wireless transmitters, enroll the serial number and loop number.</p> <ol style="list-style-type: none"> <ol style="list-style-type: none"> Transmit two open/close sequences. If using a button-type transmitter, press and release the button twice, but wait about 4 seconds before pressing the button the second time. OR Manually enter the 7-digit serial number printed on the label of the transmitter. Press the [*] key to move to the "L" position, then enter the loop number (see Loop Identification chart on back cover). If desired, you can press the [C] key to copy the previously enrolled serial number (used when programming a transmitter with several input loops). The cursor moves to the loop number position. To delete an existing serial number, enter 0 in the loop number field. The serial number will change to 0's. If 0 was entered in error, simply re-enter the loop number or press [#], and the serial number will return to the display. <p>2. Press [*] to continue. The system now checks for a duplicate serial/loop number combination.</p>																								

<pre>10 INPUT S/N L A022-4064 1</pre>	<p>If the serial/loop number combination is not a duplicate in the system, a display showing the serial number and loop number entry appears. [*] to continue</p>
<pre>XMIT TO CONFIRM PRESS * TO SKIP</pre>	<p>This prompt will only appear if you answered "Yes" at the "SET TO CONFIRM" prompt. The system now enters a confirmation mode so that the operation of the actual programmed input can be confirmed. Activate the loop input or button that corresponds to this zone. [*] to continue</p>
<pre>Entd A022-4063 1 Rcvd A022-4064 1</pre>	<p>If the serial number transmitted does not match the serial number entered, a display similar to the one shown appears. If the loop number does not match, it will also be displayed. If so, activate the loop input or button on the transmitter once again. If a match is not obtained (i.e., summary display does not appear), press the [#] key twice and then enter (or transmit) the correct serial number. [*] to continue</p>
<pre>Zn ZT RC In: L 10 03 10 RF: 1s</pre>	<p>If the serial number transmitted matches the serial number entered, the keypad will beep 3 times and a summary display will appear, showing that zone's programming. Note that an "s" indicates that a transmitter's serial number has been enrolled. [*] to accept the zone information and continue</p>
<pre>PROGRAM ALPHA? 0 = NO 1 = YES 0</pre>	<p>If you want to program descriptors for the zone now, enter 1 (yes) and refer to the *82 Descriptor Programming section for procedures. To program descriptors later, enter 0 (no). [*] to continue</p>
<pre>ENTER ZN NUM. (00 = QUIT) 11</pre>	<p>If 0 (No) was entered at the Program Alpha prompt, the system will return you to the ZONE NUMBER prompt. Repeat these steps for each zone in the system. When all zones have been programmed, enter 00 as the zone number to quit. [*] to continue</p>

Completing Zone Programming

When you have finished programming all zones, test each zone using the system's TEST mode. **Do not use the Transmitter ID Sniffer Mode for checking wireless transmitting devices**, as it will only check for transmission of one zone on a particular transmitter, NOT the zones assigned to each additional loop.

NOTE: Following the successful enrollment of each wireless device, note the device serial number in the appropriate column on the ENROLLED TRANSMITTERS worksheet in the Programming Form; then enter the other information (zone number, zone type, loop number, etc.) relevant to that device.

*58 EXPERT PROGRAMMING MODE

(press *58 while in Data Programming mode)

<pre>SET TO CONFIRM? 0 = NO 1 = YES</pre>	<p>We recommend that you select "yes" to confirm the programming of every transmitter. If selected, a prompt appears after entering the serial and loop numbers to confirm each transmitter)</p>
<pre>Zn ZT RC HW: RT 01 09 10 EL 1</pre>	<p>A summary screen will appear, showing zone 1's currently programmed values. Enter the zone number being programmed, then press [*]. In this example, zone 10 is being entered (see Zone Number prompt in *56 Menu Mode for zone numbers). [D] = for assigning wireless key programming templates (see Wireless Key Programming Templates section below); lets you choose from a series of preset templates for easy programming of wireless key zones 00 = quit (when all zones have been programmed, press "00" to quit this menu mode) [*] to continue</p>
<pre>Zn ZT RC IN: L 10 00 10 RF -</pre>	<p>A summary screen with the selected zone's current programming appears. Begin programming zone information as follows: Enter Zone Type (ZT; see Zone Types listed in *56 Menu Mode "Zone Type" prompt), Report Code (RC; 0-9 only; use *56 mode to enter hex codes), and Input Device Type (IN)* sequentially (Loop Number (L) is entered at the next prompt).</p> <ul style="list-style-type: none"> • Use the [A] (Advance) and [B] (Back) keys on the keypad to move the cursor within the screen. • Use the [C] key to copy the previous zones attributes. <p>* If HW (hardwired) or AW (Auxiliary) is entered for Input Device Type, the display will be similar to the prompt shown, except that HW or AW will be under "IN".</p>
<pre>Zn ZT RC IN: L 10 00 10 RF 1</pre>	<p>Press [*] to save the programming and continue. If needed, press the [#] key to back up without saving. For wireless devices (input types RF, UR, BR), continue to the serial number/loop number prompt. For wired devices, return to the initial summary screen prompt to begin programming the next zone.</p>
<pre>10 INPUT S/N: L AXXX-XXX -</pre>	<p>Manually enter the serial number (found on the transmitter label), by typing digits in the "X" locations, using the [A] (advance) or [B] (back) keys as required. OR</p>
<pre>Zn ZTP RC In L 10 03 1 10 RF:1s</pre>	<p>Transmit two open/close sequences. If using a button-type transmitter, press and release the button twice, but wait about 4 seconds before pressing the button the second time. If you want to copy the previous zone's serial number, press the [C] key. Press [*] to advance to the loop number, then enter loop number. Press [*] to accept the existing serial and loop number and continue to the "Confirm" prompt described in *56 Menu mode above. If necessary, press [#] to back up and re-enter or edit the serial number. If the serial number transmitted matches the serial number entered, the keypad will beep 3 times and a summary display will appear, showing the programmed information for that zone. Press [*] to begin programming the next zone. See first "Summary Screen" prompt paragraph.</p>

WIRELESS KEY PROGRAMMING TEMPLATES

(press the [D] key from *58 Menu mode Summary Screen display)

This procedure programs the wireless keys, **but a key is not active for arming/disarming until it is assigned to a user number** (see System Operation section, assigning attributes command in the Installation Instructions).

TEMPLATE ?	
1-6	1

Enter desired template number 1-6 (see chart on previous page).
Press [#] if you want to return to *58 Menu mode Summary Screen.
If necessary, press [#] to back up and re-enter template number.
Press [*] to continue to template display.

L	01	02	03	04
T	23	22	21	23

The selected template is displayed.
Top line of display represents loop numbers, bottom line represents zone type assigned for each loop.
Press [*] to accept template and continue.

ENTER START ZONE	
00 = QUIT	36

The system will search for the highest available consecutive 4-zone group (the four zones in the case of the 5804 and 5804BD), and display the lowest zone number of the group.
If you want to start at a different zone, enter the zone desired, and press [*]. If that zone number is displayed, the system has the required number of consecutive zones available, beginning with the zone you entered. If not, the system will again display a suggested zone that can be used.
If the required number of consecutive zones is not available at all, the system will display "00".
Press [*] to accept and continue.

INPUT S/N	L
AXXX-XXXX	-

Manually enter the serial number printed on the label for the wireless key or press and release the button to transmit its serial number.
Press [*] to accept the serial number. The system will check for duplicate.
If necessary, press the [#] key to back up without saving, and re-enter the serial number.
Use the [A] key to move forward within the screen, and the [B] key to move backward.

XMIT TO CONFIRM	
PRESS * TO SKIP	

If "Yes" was entered at the SET TO CONFIRM? prompt (first prompt following entry into the *58 Expert Programming Mode), this display appears.
Confirm serial and loop numbers by activating the wireless key. Refer to the "Confirm" prompt described in *56 Menu mode above for more information on confirming the serial number.
If the serial number transmitted matches the serial number entered, the keypad will beep 3 times and will return you to the ENTER START ZONE NUMBER prompt to enter the starting zone for the next wireless key.
IMPORTANT: When confirmed, the key is not active for arming/disarming until it is assigned to a user number (using the assigning attributes command, attribute "4"). See System Operation section in Installation Instructions.
[*] to skip confirm.

Wireless Key Predefined Default Templates

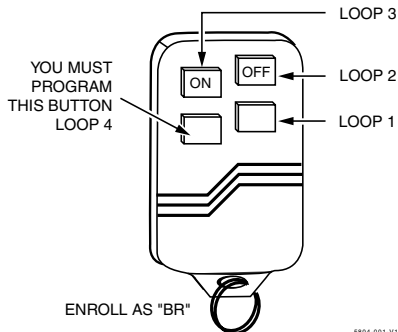

Note:
These transmitters are not intended for use in UL installations.

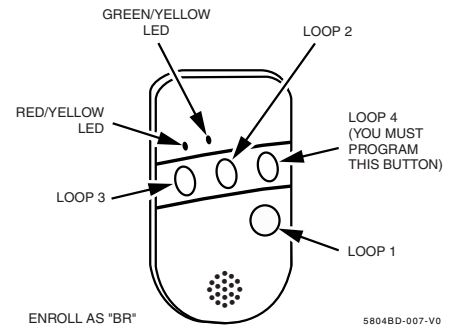

5804 Wireless Key Transmitter

5804BD 2-Way Wireless Key Transmitter

For 5804	Loop	Function	Zone Type	For 5804BD	Loop	Function	Zone Type
TEMPLATE 1	1	No Response	23	TEMPLATE 4	1	No Response	23
	2	Disarm	22		2	No Response	23
	3	Arm Away	21		3	Arm Away	21
	4	No Response	23		4	Disarm	22
TEMPLATE 2	1	No Response	23	TEMPLATE 5	1	No Response	23
	2	Disarm	22		2	Arm Stay	20
	3	Arm Away	21		3	Arm Away	21
	4	Arm Stay	20		4	Disarm	22
TEMPLATE 3	1	24-hour audible	7	TEMPLATE 6	1	24-hour audible	7
	2	Disarm	22		2	Arm Stay	20
	3	Arm Away	21		3	Arm Away	21
	4	Arm Stay	20		4	Disarm	22

*57 FUNCTION KEY PROGRAMMING MODE

(press *57 while in Data Programming mode)

The system provides the ability to program each of the four keypad function keys to perform one of 12 system operations. The end user can then activate the function by simply pressing and holding the programmed key for 2 seconds. Typical functions (listed below) include single-button arming, turning lights on/off, or single-button paging.

To assign emergency key functions (function key option "00"), first program the respective emergency zone number (95 for "A" key, 96 for "C" key, 99 for "B" key) with the desired zone type using *56 (or *58) Zone Programming mode, then use *57 Function Key menu mode to assign the desired key.

To use a function key to activate a relay action (*57 Menu mode key function 07), use *79 Menu mode to map the output, and use *80 Menu mode to define the output's action; select system operation type "66."

To use a function key for a user macro, use *57 menu mode to activate the desired key, then define the actual macro functions using the user code + [#] + [6] [6] command.

Press Key to Pgm
0 = Quit 0

Press the desired function key, A-D.

NOTE: A key programmed as a function key is no longer available to be used as an end-user macro key or panic key. [*] to continue



Key "A" Func
Zone 95 00

Enter the desired function for this key:

00 = For the Function key selected, the functions are pre-defined as follows (system default):

- If A selected = Zone 95 (emergency key, same as [1] [*] pair)
- If B selected = Zone 99 (emergency key, same as [*] [#] pair)
- If C selected = Zone 96 (emergency key, same as [3] [#] pair)
- If D selected = Single-button paging

- 01 = Single-button paging (sends a 999-9999 message to pager)
- 02 = Display time
- 03 = Arm AWAY (reports as User 00 if closing reports are enabled)
- 04 = Arm STAY (reports as User 00 if closing reports are enabled)
- 05 = Arm NIGHT-STAY (reports as User 00 if closing reports enabled)
- 06 = Step Arming (arms STAY, then NIGHT-STAY if enabled by listing zones in Zone List 5, then AWAY)
- 07 = Output Device Command (for device programmed as system operation type 66 in *80 Menu Mode)
- 08 = Communication Test (sends Contact ID code 601)
- 09 = Macro Key (defined by [#] [6] [6] command)

[*] to continue; returns to key number prompt with the next function key letter displayed.

OUTPUT DEVICE PROGRAMMING OVERVIEW (*79/*80 MENU MODE)

Output Devices:

The system supports up to 4 relays plus 2 built-in trigger outputs. These "output devices" are assigned to system-wide output numbers (01-04, 17, 18). Relays are identified by the relay module's device address and the relay position on the module (i.e. the physical relay number, 1-4, on the module). Built-in triggers are identified by the output number, 17 for Trigger 1 and/or 18 for Trigger 2. Use *79 Menu Mode to assign output numbers and map them to device addresses.

To program a device for manual activation (user code + [#] [7] / [#] [8] + 2-digit device number) or for scheduled automatic activation, simply map the device using *79 Menu mode.

To program a device to automatically activate upon a system event (or function key), use *79 Menu mode to map the device, then use *80 Menu mode to define the automated device action.

NOTE: You must map output devices using *79 Menu Mode **before** you can use *80 menu Mode.

Output Functions:

The system also provides up to 12 installer-defined output functions, which can be assigned to any of the physical outputs. Therefore, the action of any one of the outputs can be based on as many of these functions as desired. This lets a single relay perform many functions. Use *80 Menu Mode to define output functions, which control the output devices. If the device action is based on more than one zone, use *81 Zone List menu mode to assign the zones.

IMPORTANT: Relays are not recommended for life safety applications.

MENU NAVIGATION NOTE: For *79 and *80 menus, press the [*] key to accept an entry and advance to the next prompt. Use the [#] key to go back to the last question if needed (to check or change an entry). Press [*] to go forward again.

*79 OUTPUT DEVICE MAPPING

(press *79 while in Data Programming Mode)

Use this menu to assign the Relay Module device address and specific relay numbers. The system is based on predefined module addresses. The address for the 4204 is 12. Refer to the "Module Address" prompt and set the module's address (via module DIP switches) accordingly.

ENTER OUTPUT NO. 00 = QUIT xx	Enter the logical (or reference) relay number as used in the system. 01-04 = relays; 17-18 = on-board triggers (can be programmed for inverted output; see next prompt) [*] to continue
17 OUT NORM LOW 0 = NO 1 = YES 0	This prompt appears only for triggers 17 and 18. 0 = no (standard default); sets the trigger output level normally high 1 = yes; sets the trigger output normally low (can be used for resetting 4-wire smoke detectors by connecting trigger wire to the negative power terminal of the smoke detector, selecting 1 at this prompt, and setting as zone type 54, fire zone reset, in *80 Menu mode) [*] to return to Output Number prompt
XX OUTPUT TYPE DELETE? 0	Enable or delete this output. 0 = delete this output number; 1 = enable output [*] to continue
XX MODULE ADDR 07-15 yy	Enter the module's predefined address "12" (set the module's DIP switches to "12"). [*] to continue
XX REL POSITION 1-4 zz	Enter the actual (or physical) relay number, 1-4, with respect to the Relay Module upon which it is located. [*] to return to the Output Number prompt for programming the next device

*80 OUTPUT DEFINITION MODE

(press *80 while in Data Programming mode)

Use this mode to program output function definitions (up to 12 functions) that provide automated control of any of the output devices, based on events occurring on individual zones or zones with certain zone types. Each output definition is identified by an output function number, and includes the following components:

Output Definition Components

Component	Description
Output Function No.	A reference number that defines an output's characteristics.
Activated By	Determines whether the initiating event occurs on a zone, a zone list, or a zone type.
Event	Event that triggers the output action. Can be an event occurring on a specific zone number or a zone list, or a specific zone type.
Output Action	Defines the action of the relay when the defined event occurs. Can close for 2 seconds, stay closed until reset, continuously pulse (1-second close-open-close-open, etc.), toggle the device state, or activate for a defined duration (set in data field *177).
Output No.	Assigns this function to a specific output number (defined in *79 Menu Mode). This is the output number that will perform this function upon the triggering event. Note that each defined function is associated with only one output number. This means that if more than one output device needs to perform this particular function, you need to define another output function number with the same attributes, but assign the appropriate output number. (i.e. output devices can be assigned more than one function number, but each function number can only be assigned a single output number.

Output Funct. # (00 = Quit) 01	Enter the output function number to be defined 01-12 = output function number [*] to continue; 00 = exit
01 A E Trig ?00 0 0 - ZL=00	This screen displays a summary of the current output programming A = Output Action; E = Triggering event; Trig = Trigger type Question mark indicates the device shown has not been mapped. Use *79 Menu mode to map the device. [*] to continue
01 Activated By: Zone List	Select where the initiating event for this output definition is to occur. 0 = delete (deletes the output function and any previous programming) <div style="border: 1px solid black; padding: 2px; display: inline-block; margin: 5px;"> Delete? 0 = NO, 1 = YES </div> To delete this output definition, press 1. If you do not want to delete this output, press 0. 1 = zone list (go to "A" prompt); 2 = zone type (go to "B" prompt); 3 = zone number (go to "C" prompt) [*] to continue

"A"

01 Zn List 1

If zone list was selected, this screen appears. Otherwise skip to the next prompt. Enter the desired zone list number associated with this output number: 01-08 = zone list (Do not use pager zone list 09 in output definitions) Enter the zone list event that will activate this output:

Enter Event Alarm 1

0 = restore; 1 = alarm; 2 = fault; 3= trouble

NOTE: For alarm, fault, and trouble, an event on ANY zone in the list activates the output, but ALL zones in the list must be restored before the output is restored. Press [*] to continue and skip to the "Output Action" prompt.

"B"

01 Enter Zn type Perimeter 03

If zone type was selected, this screen appears. Otherwise skip to the next prompt. Enter the desired zone type for this output number.

CHOICES FOR ZONE TYPES:

- 00 = Not Used 05 = Trouble Day/Alarm Night 12 = Monitor Zone
01 = Ent/Exit #1 06 = 24 Hr Silent 14 = Carbon Monoxide
02 = Ent/Exit #2 07 = 24 Hr Audible 16 = Fire w/verification
03 = Perimeter 08 = 24 Hr Aux 23 = No Alarm Response
04 = Interior Follower 09 = Fire 24 = Silent Burglary
10 = Interior w/Delay 77 = Keyswitch Zone
81 = AAV Monitor Zone
90 = Configurable

CHOICES FOR SYSTEM OPERATION:

- 20 = Arming-Stay 36 = At Bell Timeout*** 52 = Kissoff
21 = Arming-Away 38 = Chime 54 = Fire Zone Reset
22 = Disarming 39 = Any Fire Alarm 58 = Duress
31 = End of Exit Time 40 = Bypassing 60 = AAV
32 = Start of Entry Time 41 = AC Power Failure 66 = Function Key†
33 = Any Burglary Alarm 42 = System Battery Low 67 = Bell Fail
43 = Comm. Failure 68 = Telco line cut
78 = Keyswitch Red LED
79 = Keyswitch Green LED

*** Or at Disarming, whichever occurs earlier.

† Use *57 Menu Mode to assign the function key (function "07").

Note: In normal operation mode: Code + # + 7 + NN Key Entry starts Device NN. Code + # + 8 + NN Key Entry stops Device NN.

Press [*] to continue and skip to the "Output Action" prompt.

"C"

01 Enter Zn No. 12

If zone number was selected, this screen appears. Enter the desired zone number associated with this output number. Press [*] to continue. Enter the zone event that will activate this output.

01 Enter Event Restore 0

0 = restore; 1 = alarm/fault/trouble

Press [*] to continue to the "Output Action" prompt

01 Output Action Close for 2 sec 1

Enter the desired device action as listed below. 0 = off 4 = Change Device State 1 = Close for 2 seconds 5 = Duration 1 (see data field *177) 2 = Stay Closed 6 = Duration 2 (see data field *177) 3 = Pulse 1 sec ON, 1 sec OFF Press [*] to continue.

Enter Output No. R02 02

Enter the device output number (programmed in *79 Menu Mode) you want associated with this output. 01-04 = output no. 17-18 = on-board triggers Press [*] to continue.

02 A E P TRIG R02 1 1 3 ZL=1

A summary screen appears showing the programmed settings. Press [*] to return to output function number prompt.

*81 ZONE LIST PROGRAM MODE

(press *81 while in Data Programming mode)

Zone lists let you group individual zones for use with certain system actions. The following table shows the available zone lists and their purposes:

List No.	Used for...
1, 2	general purpose
3	chime-by-zone
4	cross zones
5	night stay zones
6	general purpose VISTA-10PSIA : dial delay disable
7	general purpose VISTA-10PSIA : unlimited reports
8	general purpose
9	zones that activate Pager 1

Zone List No.	
(00 = Quit) 01	

Enter the Zone List Number to program (or 00 to end these entries).
01-09 = zone list number
[*] to continue

01 Enter Zn Num.	
(00 = Quit) 00	

Enter each zone number followed by [*] to add each zone to the zone list.
01-06 = wired zones; 09-24 = wireless zones; 49-56 = button zones
91 = addr. device report enable (Enter a report code for zone 91 to enable addressable device reporting.
92 = duress report enable (Enter a report code for zone 92 to enable duress reporting)
95, 96, 99 =emergency zones
00 to continue
IMPORTANT: Do not include fire zones in zone lists that are used to STOP device actions.

01 Del Zn List?	
0 = No 1 = Yes 0	

0 = don't delete list; current zone list remains saved
1 = delete this zone list; All zones in the zone list will be deleted automatically and the system returns to the Zone List No. prompt.
[*] to continue

01 Delete Zone?	
0 = No 1 = Yes 0	

0 = don't delete zones; save zone list and return to the Zone List No. prompt.
1 = go to next prompt to delete zones
[*] to continue

01 Zn to Delete?	
(00 = Quit) 00	

Enter each zone to be deleted from the list
01-64 = zones to be deleted from list followed by [*] to accept each zone
00 when done to return to the Zone List No. prompt

NOTES:

- Any list may include any or all of the system's zone numbers.
- A zone list can be assigned to more than one output relay.
- When creating zone list 4 for cross zoning, include only zones assigned to zone types 3, 4, or 5. Do not include zones that have delays (entry/exit zones, interior w/delay) or 24-hour zones, as these zone types may produce unpredictable operation and may not function as intended. See field *85 for Cross Zone Timer option.
- Zone List 6: **VISTA-10PSIA**: See field *50 for Dial Delay Disable option.
- Zone List 7: **VISTA-10PSIA**: See field *93 for Unlimited Reports option.

*82 ZONE DESCRIPTOR PROGRAMMING MODE

(press *82 while in Data Programming mode)

The system lets you assign zone descriptors for protection zones, keypad panics, and RF receiver supervision faults. Each description can be composed of a combination of words (up to 3) selected from a vocabulary of 196 words stored in memory (see a following page). In addition, up to 10 installer-defined words can be added to those already in memory. Thus, when an alarm or trouble occurs in a zone, an appropriate description for that zone's location can be displayed at the keypad. Zone descriptors are recommended for systems using Alpha display keypads, and are necessary if a Phone Module is used.

NOTE: You can enter zone descriptors when the zone is being defined in *56 Menu mode, but we recommend you do it using *82 Menu mode.

If using a 4286VIP Phone Module, select from those words in the Alpha Vocabulary List shown in **boldface type**. The phone module will not provide annunciation of the other words.

If a 4286 Phone Module is added to an existing system, the Alpha descriptors presently in the system should be reprogrammed, selecting from those words shown in **boldface type** in the Alpha Vocabulary List. The phone module will not provide annunciation of any other words.

When defining descriptors:

- Pressing the [6] key accepts the entered index number and moves the cursor to the next position.
- Pressing the [8] key saves the entered descriptor and moves to the next descriptor.

Program Alpha ?
0=No, 1=Yes 0

Press 1 to program descriptors.
0 = exit this mode

Custom Words ?
0=No, 1=Yes 00

To program standard alpha descriptors from the fixed vocabulary, press 0. The system will then automatically display the descriptor for zone 1.
To define custom words (described below in "Adding Custom Words" section), press 1.

* ZN 01

Summary screen of zone 1 descriptor (if programmed) is displayed.
Press [*] to start blinking cursor at zone number, then enter the zone number for which the descriptor is being programmed.

- If a descriptor is programmed for that zone, it is displayed.
- To delete or change a previously programmed descriptor, press the same zone number. This will clear that descriptor and move the cursor to the first word position.
- If you do not wish to change the existing descriptor, enter the next zone number for which you wish to enter (or check) a descriptor. A summary display for that zone will appear. You must then enter the same zone number again to program a descriptor for that zone.
- If no descriptor has been programmed for that zone, the cursor moves to first word position.

* ZN 01

Select first word of descriptor:
Press [#] plus the 3-digit index number for the first word from the Alpha Vocabulary List. See index for entries.
Example: The descriptor that we wish to enter for zone 1 is BACK DOOR. From the list, BACK = 013.
Therefore, you would enter #013.
NOTE: If you enter the wrong word, simply press [#] plus the correct 3-digit number for the word you want.

* ZN 01 BACK

Save first word of descriptor:
6 = save word and go to next word in this descriptor
8 = save word and end descriptor if this is the only word used for the descriptor - go to summary screen

* ZN 01 BACK
D O O R

Enter the 3-digit number for the next word. In the example, the word is DOOR, whose number is "057."
See index for entries.
[*] to continue

* ZN 01 BACK
D O O R

Save second word of descriptor:
6 = save word and go to next word in this descriptor
8 = save word and end descriptor if this is the only word of the descriptor - go to summary screen
The two words in the example have now been entered. Note, however, that up to three words may be entered (provided the number of characters will fit on the screen).

* ZN 01 BACK
D O O R

Summary Screen
The blinking cursor will disappear, indicating that the word(s) are stored in memory for that zone.
To enter a descriptor for the next zone, press [*] plus the desired zone number (e.g., *02).
The summary display for that zone will appear.
Repeat the previous steps to enter the descriptor for the next zone.

To exit the Alpha descriptor mode, enter zone "00" at the summary display, which returns you to the Program Alpha prompt. Enter "0" at that prompt to exit.

ADDING CUSTOM WORDS

(will not be annunciated by 4286 Phone Module)

Program Alpha ?
0=No, 1=Yes 0

The "Program Alpha ?" prompt will appear.
1 = program zone descriptors, custom message, or reminder words
[*] to continue; 0 = exit

Custom Words ?
0=No, 1=Yes 0

Custom words let you assign custom zone descriptors, a custom message (which replaces the "DISARMED READY TO ARM" message), and "reminder" words (for Scheduling mode, event "10").

NOTE: Do not assign reminder words if using fixed-word keypads.

1 = yes, program custom words or reminder words; 0 = no, go to zone descriptors (see above)
If "1" selected, enter the 2-digit custom word number (01-10, or 11 for custom message) to be programmed, corresponding to index numbers 245 - 254 respectively (for example, if you are creating the first custom word or word-string, enter 01, for the second, enter 02, etc.). A cursor appears at the beginning of the second line.

Custom? 00

01-07 = custom words; 08-10 = "reminder" words used with scheduling mode
11 = custom message (replaces "DISARMED READY TO ARM" message)

Custom? 01

A cursor appears at the beginning of the second line.

Special Keys: [6] = accept character and move cursor to next position to right
[4] = move cursor to left
[8] = save custom word

1. Refer to the Character Chart on the next page.
Press [#], followed by the two-digit entry for the first letter you want to display (e.g., # 6 5 for "A").
Press [6] to accept the character and move the cursor to the right, in position for the next character.
2. Repeat Step 1 to enter the next characters until the desired custom word is entered. You can use the [4] key to move the cursor to the left, if necessary.
Each custom word can be a maximum of 10 characters.
3. When done, press the [8] key to save the custom word and return to the "Custom ?" prompt.
4. Repeat steps 1-3 to enter other custom words. To change a custom word, simply overwrite it.
To exit, enter "00," which returns you to the Program Alpha prompt. Enter "0" at that prompt to exit.

ALPHA VOCABULARY LIST (For Entering Zone Descriptors)

000 (Word Space)	• 057 DOOR *	- L -	- R -	- V -
• 001 AIR	• 059 DOWN	• 106 LAUNDRY *	155 RADIO	209 VALVE
• 002 ALARM *	• 060 DOWNSTAIRS	• 107 LEFT	• 156 REAR	210 VAULT
004 ALLEY	061 DRAWER	108 LEVEL	157 RECREATION	212 VOLTAGE
005 AMBUSH	• 062 DRIVEWAY	• 109 LIBRARY *	159 REFRIGERATION	- W -
• 006 AREA	• 064 DUCT	• 110 LIGHT	160 RF	213 WALL
• 007 APARTMENT	- E -	111 LINE	• 161 RIGHT	214 WAREHOUSE
• 009 ATTIC *	• 065 EAST	• 113 LIVING *	• 162 ROOM *	• 216 WEST
010 AUDIO	066 ELECTRIC	• 114 LOADING	163 ROOF	• 217 WINDOW *
- B -	067 EMERGENCY *	115 LOCK	- S -	• 219 WING
• 012 BABY *	068 ENTRY	116 LOOP	164 SAFE	220 WIRELESS
• 013 BACK *	• 069 EQUIPMENT	117 LOW	165 SCREEN	- X -
• 014 BAR	• 071 EXIT *	• 118 LOWER	166 SENSOR	222 XMITTER
• 016 BASEMENT *	072 EXTERIOR	- M -	• 167 SERVICE	- Y -
• 017 BATHROOM *	- F -	• 119 MACHINE	• 168 SHED *	223 YARD
• 018 BED	• 073 FACTORY	121 MAIDS	169 SHOCK	- Z -
• 019 BEDROOM *	075 FAMILY	122 MAIN *	• 170 SHOP *	224 ZONE (No.)
020 BELL	• 076 FATHERS	• 123 MASTER *	171 SHORT	• 225 ZONE *
• 021 BLOWER	• 077 FENCE	• 125 MEDICAL *	• 173 SIDE *	• 226 0
• 022 BOILER	• 079 FIRE *	126 MEDICINE	174 SKYLIGHT	• 227 1
023 BOTTOM	• 080 FLOOR *	128 MONEY	175 SLIDING *	• 228 1ST *
025 BREAK	081 FLOW	129 MONITOR	• 176 SMOKE *	• 229 2
• 026 BUILDING	082 FOIL	• 130 MOTHERS	• 178 SONS	• 230 2ND *
- C -	• 083 FOYER	• 131 MOTION *	• 179 SOUTH	• 231 3
028 CABINET	084 FREEZER	132 MOTOR	180 SPRINKLER	• 232 3RD *
• 029 CALL	• 085 FRONT *	- N -	• 182 STATION	• 233 4
030 CAMERA	- G -	• 134 NORTH	184 STORE	• 234 4TH
031 CAR	• 089 GARAGE *	135 NURSE	• 185 STORAGE *	• 235 5
033 CASH	• 090 GAS	- O -	186 STORY	• 236 5TH
034 CCTV	091 GATE	• 136 OFFICE *	190 SUPERVISED *	• 237 6
035 CEILING	• 092 GLASS	• 138 OPEN *	191 SUPERVISION	• 238 6TH
036 CELLAR	093 GUEST	139 OPENING	192 SWIMMING	• 239 7
• 037 CENTRAL	094 GUN	• 140 OUTSIDE	193 SWITCH	• 240 7TH
038 CIRCUIT	- H -	142 OVERHEAD	- T -	• 241 8
• 040 CLOSED *	• 095 HALL *	- P -	194 TAMPER	• 242 8TH
• 046 COMPUTER	• 096 HEAT	143 PAINTING	196 TELCO	• 243 9
047 CONTACT	098 HOLDUP	• 144 PANIC *	197 TELEPHONE	• 244 9TH
- D -	099 HOUSE *	145 PASSIVE	• 199 TEMPERATURE	245 Custom Word #1
• 048 DAUGHTERS	100 INFRARED	• 146 PATIO *	200 THERMOSTAT	246 Custom Word #2
049 DELAYED	• 101 INSIDE *	147 PERIMETER	• 201 TOOL	247 Custom Word #3
• 050 DEN *	102 INTERIOR	• 148 PHONE	202 TRANSMITTER	248 Custom Word #4
051 DESK	103 INTRUSION	150 POINT	- U -	249 Custom Word #5
• 052 DETECTOR *	- J -	151 POLICE *	• 205 UP	250 Custom Word #6
• 053 DINING *	104 JEWELRY	152 POOL *	• 206 UPPER	251 Custom Word #7
054 DISCRIMINATOR	- K -	• 153 POWER	• 207 UPSTAIRS *	252 Custom Word #8
055 DISPLAY	• 105 KITCHEN *		• 208 UTILITY *	253 Custom Word #9
				254 Custom Word #10

NOTE: Bulleted (*) words in **boldface type** are those that are also available for use by the 4286 Phone Module. If using a Phone module, and words other than these are selected for Alpha descriptors, the module will not provide announcement of those words. *Italicized* words followed by an asterisk indicate those words supported by the 6160V/6150V Voice Keypads

CHARACTER (ASCII) CHART (For Adding Custom Words)

32 (space)	41)	50 2	59 ;	68 D	77 M	86 V
33 !	42 *	51 3	60 <	69 E	78 N	87 W
34 "	43 +	52 4	61 =	70 F	79 O	88 X
35 #	44 ,	53 5	62 >	71 G	80 P	89 Y
36 \$	45 -	54 6	63 ?	72 H	81 Q	90 Z
37 %	46 .	55 7	64 @	73 I	82 R	
38 &	47 /	56 8	65 A	74 J	83 S	
39 '	48 0	57 9	66 B	75 K	84 T	
40 (49 1	58 :	67 C	76 L	85 U	

SCHEDULING MODE

Start Scheduling mode by entering installer code + [#] + [6] [4] while in normal operating mode.

The system provides 2 schedules (one for the installer, one for the end user), which can be used to control 11 types of system events at pre-defined times.

- NOTES:**
- The master code can only access schedule 01 and events 00-07.
 - System clock must be set before schedules can take effect.
 - Programmed schedules do not take effect until the next scheduled “start” time. (e.g., if programming a schedule time window for 8AM to 5PM, the schedule does not take effect until 8AM after the schedule has been programmed.)

<p>ENTER SCHED NO. 00=QUIT 00</p>	<p>Enter the desired schedule number. 01 = end-user schedule; 02 = installer-only schedule; 00 = exit scheduling mode [*] to continue</p>
<p>ENTER EVENT CLEAR EVENT 00</p>	<p>Enter the desired event number for event you want to occur at a specified time. Events 10-11 are reserved for the installer only.</p>
<p>NOTE: Events 07 and 10 cause the keypad to beep every 30 seconds when messages are displayed. Stop the beeps by pressing any key.</p>	<p>00 = clear event 01 = Relay On/Off 02 = User Access 03 = Latch Key Report to Pager (sent to all pagers; message sent is 777-7777; user must be enabled for paging and system must be armed before reporting can occur.) 04 = Forced Stay Arming (forced bypass is automatically enabled regardless of setting in field *23) 05 = Forced Away Arming (forced bypass is automatically enabled regardless of setting in field *23) 06 = Auto Disarm 07 = Display “Reminder” 10 = Display custom words (system displays custom words 8, 9, and 10 at defined time; can be used as installer’s reminder message to the end user) 11 = Periodic Test Report [*] to continue</p>
<p>DEVICE NUMBER XX</p>	<p>This prompt appears if event “1” (relay on/off) was selected, otherwise it is skipped. Enter the physical device number as programmed in *79 Menu Mode. 01-04 = device number; 17, 18 = built-in triggers 1 and 2 respectively [*] to continue to the “Start” prompt</p>
<p>GROUP NUMBER X</p>	<p>This prompt appears if event “2” (user access) was selected. Otherwise it is skipped. 1-8 = group number [*] to continue to the “Start” prompt</p>
<p>START SMTWTFS HH MMAM 0010000</p>	<p>Enter the event’s start time and days of the week to occur. 01-12 = hour; 00-59 = minute; 0 = AM; 1 = PM Days = position the cursor under the desired days using the [*] key to move forward, then press “1” to select the desired day(s) [*] to continue</p>
<p>STOP SMTWTFS HH MMAM 0010000</p>	<p>Enter the event’s stop time and days of the week to occur. This entry applies only to the following events: 1 (relay on/off); 2 (user access); 3 (latch key report) 01-12 = hour; 00-59 = minute; 0 = AM; 1 = PM Days = position the cursor under the desired days using the [*] key to move forward, then press “1” to select the desired day(s) [*] to continue</p>
<p>REPEAT OPTION 0-4 X</p>	<p>Enter the desired repeat option for this schedule. e.g., To make a schedule that happens everyday you would select all days with a repeat count of 1. To make a schedule that runs for one week then stops, select everyday with a repeat count of 0. 0 = do not repeat; 1 = repeat schedule weekly; 2 = repeat schedule biweekly (every other week) 3 = repeat every 3rd week; 4 = repeat every 4th week (28 days) [*] to continue</p>
<p>RANDOMIZE 0=NO 1=YES X</p>	<p>Select whether you want this schedule to start and stop at random times. If selected, the scheduled start and stop times will vary within 60 minutes of the “hour” time. For example, if a schedule is set to start at 6:15pm, it will do so the first time 6:15pm arrives, but on subsequent days it will start anytime between 6:00 and 6:59 p.m. [*] to continue NOTE: Do not use the random option if the start and stop times are within the same “hour” setting, otherwise unpredictable results may occur (e.g., the randomized stop time may occur before the start time).</p>

*29 COMMUNICATION DEVICE MENU MODE (Pass-Through Programming)

This mode is for programming an IP, GSM, or IP/GSM Communicator Module using an alpha keypad. Alternatively, these options can be programmed via the AlarmNet Direct website. After programming is complete, the module must be registered with AlarmNet before reporting via the communication device can occur. Refer to the device's instructions for registration procedures.

NOTE: The module must be set to device address 3.

IMPORTANT: The use of an IP/GSM Communicator Module requires an AlarmNet-I account. Please obtain the account information from the central station prior to programming this module.

Using an Alpha Keypad as a 7720P Programming Tool

When programming with *29 menu mode, the alpha keypad mimics the functions of the 7720P Programming Tool. See figure to right and table below for 7720P key functions. Each key has two possible functions: a normal function and a SHIFT function.

Normal functions: The numeric values labeled directly on the keys and the left-hand functions shown in diagram on the ABC keys. To perform a normal key function, simply press the desired key.

SHIFT functions: Those functions shown in diagram above the numerical keys and the right-hand functions shown on the ABC keys. To perform a SHIFT key function, press SHIFT key (D key), then press the desired function key (shift function is indicated by the lit READY LED).

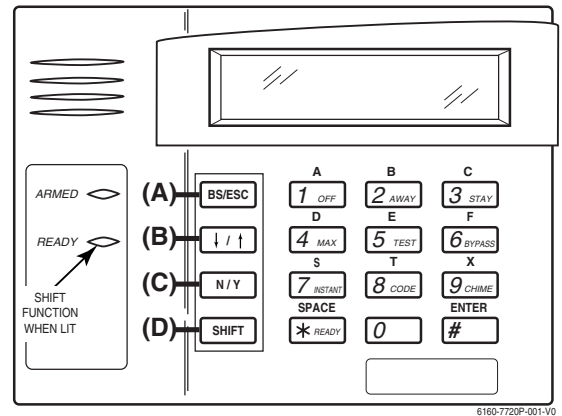

7720P Emulation Template for Alpha Keypads

*29 IP/GSM Program Mode

Press *29 while in Data Field Programming mode. The following prompts appear.

ENABLE IP/GSM?
0=No, 1=Yes

Enable IP/GSM?

0 = no, not using IP or GSM;
1 = yes using IP and/or GSM module

[*] to continue

[Default = 0 (no IP and/or GSM)]

If using a communication device, enter 1 at this prompt and enter 1-Prog at the next prompt to program and register the device. Use the Installation Guide included with the communication device for details of the device's programming prompts and instructions for registration.

1=PROG 2=DIAG
0=QUIT

Programming / Diagnostics Select

1 = Prog (program the IP/GSM options)
2 = Diag (enter diagnostic mode)
0 = Quit; returns to data field programming mode

Select whether you want to program the communication device or enter the device's diagnostic mode.

Diagnostic Mode Note: Diagnostic mode option available only for communicators with firmware version 2.4.16 or higher.

Normal and SHIFT key Functions While in *29 Menu Mode

Key	Normal Key Function	SHIFT Key Function
(A) = BS/ESC	[BS]: Press to delete entry Also, can reset EEPROM defaults †	[ESC]: Press to quit Program Mode
(B) = ↓/↑	[↓]: Scroll down programming	[↑]: Scroll up programming
(C) = N/Y	[N]: Press for "NO" answer	[Y]: Press SHIFT-Y for "YES" answer
(D) = SHIFT	Press before pressing a SHIFT key function. Will light READY LED. LED goes out once a key is pressed. Press again for each SHIFT function desired.	
1/A	[1]: For entering the number 1	[A]: Used for entering C.S. ID number
2/B	[2]: For entering the number 2	[B]: Used for entering C.S. ID number
3/C	[3]: For entering the number 3	[C]: Used for entering C.S. ID number
4/D	[4]: For entering the number 4	[D]: Used for entering C.S. ID number
5/E	[5]: For entering the number 5	[E]: Used for entering C.S. ID number
6/F	[6]: For entering the number 6	[F]: Used for entering C.S. ID number
7/S	[7]: For entering the number 7	[S]: Press to display diagnostic status
8/T	[8]: For entering the number 8	[T]: Press to send TEST messages
9/X	[9]: For entering the number 9	[X]: Press to reset the IP/GSM
[*] / SPACE	[*]: Used to select programming options	[SPACE]: Not used
0	[0]: For entering the number 0	
[#] / ENTER	[#] / ENTER: Press to accept entries	No SHIFT function

† Active only when the "REVIEW?" prompt is displayed

UPLOADING/DOWNLOADING VIA THE INTERNET

UL: Up/downloading via the Internet has not been evaluated by UL.

This control, when used with a compatible Internet/Intranet Communication Device, supports upload/download programming capability via the Internet using the AlarmNet network or, depending on the communication module used, a Private local area network (Intranet). This allows site maintenance independent of central station monitoring, and modification to sites globally via the Internet. Depending on the module used, Internet connection from the protected premises is either via high speed (broadband) cable or phone service, or via the GSM/GPRS digital cellular network (GSM modules).

Refer to the instructions provided with the communication module for information regarding its installation, programming, and registration. The System Requirements table below lists two sets of system requirements, depending upon whether you intend to communicate over the Internet or whether you are communicating over a Private LAN (Intranet).

Compatible Communication Modules: The following modules support Internet uploading/downloading, but future modules may also provide Internet upload/download support; refer to the module's instructions for compatibility. Compatible Modules: 7845i-ent, 7845i-GSM, 7845GSM

System Requirements

Internet Communication	Intranet (Private LAN) Communication, if applicable*
<p>At the Installation Site:</p> <ul style="list-style-type: none"> • Appropriate Internet Communication Module • 7720P Programmer • Broadband Internet Access (for wired modules) • Broadband (Cable/DSL) Modem (for wired modules) • Broadband (Cable/DSL) Router (for wired modules if connecting more than one device to the Internet) • IP compatible Control Panel <p>At the Downloading Office:</p> <ul style="list-style-type: none"> • Broadband Internet Access • Broadband (Cable/DSL) Modem • Broadband (Cable/DSL) Router (optional, if connecting more than one device to the Internet) • Computer running Compass Downloading Software version that supports Internet upload/download for this control. 	<p>At the Installation Site:</p> <ul style="list-style-type: none"> • Internet/Intranet Communication Module • 7720P Programmer • Ethernet Network Connection • IP compatible Control Panel <p>At the Downloading Office:</p> <ul style="list-style-type: none"> • 7810iR-ent IP Receiver • Internal Router • Computer(s) running the following software: <ul style="list-style-type: none"> - Compass Downloading Software version that supports IP upload/download for this control. - Compass Connect Data Server Application - Compass Connect Control Server Application <p>* see module's instructions for applicability for LAN usage (ex. 7845i-ent supports LAN)</p> <p>NOTE: Compass, the Compass Connect Data Server, and the Compass Connect Control Server applications may all be installed on the same computer if desired. If they are installed on one computer, the computer must have a fixed IP Address.</p>

To set up the control panel, do the following:

1. Connect the module to the control panel's ECP (keypad) terminals.
2. Internet Users: For wired modules, connect the module to the Internet via a cable/DSL modem and router.
Intranet Users: Connect the module to the Intranet (LAN) via the appropriate Ethernet connection.
3. Enable the module as a Long Range Radio in the control panel (programming field *29) to enable alarm reporting and module supervision.
4. Set the module for address 3.
5. Program the module as required using the module's programming methods (ex. 7720P programmer).
6. Register the module with AlarmNet. The module must be registered before downloading or alarm reporting can take place.

To perform upload/download functions:

1. Connect the computer to the Internet and start the Compass downloading software.
2. Open the control's account, then select the Communications function and click the **Connect** button.
3. At the Connect screen, check that the control's MAC address is entered and the TCP/IP checkbox is checked.
4. Click **Connect**. The Internet connection to the control is made automatically via AlarmNet.
5. Once connected, use the Compass downloading software as normal to perform upload/download functions.

SETTING THE REAL-TIME CLOCK

IMPORTANT: The Real-Time Clock must be set before the end of the installation.

NOTE: System must be disarmed before the date/time can be set.

1. Master Code + [#] + [6] [3]
2. Press [*] when the time/date is displayed.
A cursor appears under the first digit of the hour.
To move cursor ahead, press []. To go back, press [#].*
 - Enter the 2-digit hour setting.
 - Enter the 2-digit minute setting.
 - Press [1] for PM or [2] for AM.
 - Enter the last two digits of the current year.
 - Enter the 2-digit month setting.
 - Enter the 2-digit day setting.
3. To exit, press [*] when cursor is at the last digit, or wait 30 seconds.

ZONE TYPE DEFINITIONS

Zone types define the way in which the system responds to faults in each zone.

Type 00 Zone Not Used

Program a zone with this zone type if the zone is not used.

Type 01 Entry/Exit Burglary #1

- Assign to zones that are used for primary entry and exit.
- Provides entry delay when zone is faulted if control is armed in the Away, Stay, or Night-Stay modes.
- No entry delay provided when the panel is armed in the Instant/Maximum mode.
- Entry delay #1 is programmable (field *35).
- Exit delay begins whenever the control is armed, regardless of the arming mode selected, and is programmable (field *34).

Type 02 Entry/Exit Burglary #2

- Assign to zones that are used for entry and exit and require more time than the primary entry/exit point.
- Provides a secondary entry delay, similar to entry delay #1.
- Entry delay #2 is programmable (field *36).
- Exit delay is same as described for Type 01.

Type 03 Perimeter Burglary

- Assign to all sensors or contacts on exterior doors and windows.
- Provides an instant alarm if the zone is faulted when the panel is armed in the Away, Stay, Night-Stay, Instant or Maximum modes.

Type 04 Interior Follower

- Assign to a zone covering an area such as a foyer, lobby, or hallway through which one must pass upon entry (to and from the keypad).
- Provides a delayed alarm (using the programmed entry 1 time) if the entry/exit zone is faulted first. Otherwise this zone type gives an instant alarm.
- Active when the panel is armed in the Away mode.
- Bypassed automatically when the panel is armed in the Stay or Instant modes; if armed in Night-Stay mode, zones assigned to zone list 05 (night-stay zone list) are not bypassed when system armed in Night-Stay mode.

Type 05 Trouble by Day/Alarm by Night

- Assign to a zone that contains a foil-protected door or window (such as in a store), or to a zone covering a sensitive area such as a stock room, drug supply room, etc.
- Can also be used on a sensor or contact in an area where immediate notification of an entry is desired.
- Provides an instant alarm if faulted when armed in the Away, Stay, Night-Stay, Instant or Maximum (night) modes.
- During the disarmed state (day), the system will provide a latched trouble sounding from the keypad (and a central station report, if desired).

Type 06 24-hr Silent Alarm

- Usually assigned to a zone containing an emergency button.
- Sends a report to the central station but provides no keypad display or sounding.

Type 07 24-hour Audible Alarm

- Assign to a zone that has an emergency button.
- Sends a report to the central station, and provides an alarm sound at the keypad, and an audible external alarm.

Type 08 24-hour Auxiliary Alarm

- Assign to a zone containing an emergency button, or to a zone containing monitoring devices such as water or temperature sensors.
- Sends a report to the central station and provides an alarm sound at the keypad. (No bell output.)

Type 09 Supervised Fire

- Provides a fire alarm on short circuit and a trouble condition on open circuit. A fire alarm produces a pulsing bell output.
- This zone type is always active and cannot be bypassed.

Type 10 Interior w/Delay

- Provides entry delay (using the programmed entry time), if tripped when the panel is armed in the Away mode.
- Entry Delay 1 begins whenever sensors in this zone are violated, regardless of whether or not an entry/exit delay zone was tripped first.
- Bypassed when the panel is armed in the Stay or Instant modes; if armed in Night-Stay mode, zones assigned to zone list 05 (night-stay zone list) are not bypassed when system armed in Night-Stay mode.

Type 12 Monitor Zone

- Works as a dynamic monitor of a zone fault/trouble (not alarm). In the case of a short/open, the message, "**ALARM*-24 Hr. Non-Burg. -#XXX " (where XXX is the zone number) will be sent to the Central Station. The system keypad will display a "check" message indicating the appropriate zone (but keypad beeping does not occur). Upon restoral of the zone, the message, "**RESTORE*-24 Hr. Non-Burg. -#XXX " will be sent to the Central Station.
- The "check" message will automatically disappear from the keypad dynamically, when the zone restores; a user code + off sequence is not needed to reset the zone.
- Faults of this zone type are independent of the system, and can exist at the time of arming without interference.
- Since this is a "trouble" zone type, do not use this zone type with relays set to activate upon "alarm."

Type 14 24 Hour Carbon Monoxide Monitor

- Assigned to any zone with a carbon monoxide detector.
- A carbon monoxide alarm produces keypad and detector sounding (does not affect bell output).
- Always active and cannot be bypassed.

Type 16 Fire w/Verification

- Provides a fire alarm when zone is shorted, but only after alarm verified.
- Verifies alarm by resetting smoke detectors after short is detected (removes power 7 seconds for zone 1, 3 seconds for trigger output). Another short circuit within 90 seconds triggers fire alarm.
- Provides a trouble response when zone is open.

Type 20 Arm-Stay (BR only)

- Arms the system in Stay mode when the zone is activated.
- Pushbutton units send the user number to the central station when arming or disarming.
- User number for button must be assigned.

Type 21 Arm-Away (BR only)

- Arms the system in Away mode when the zone is activated.
- Pushbutton units send the user number to the central station when arming or disarming.
- User number for button must be assigned.

Type 22 Disarm (BR only)

- Disarms the system when the zone is activated.
- User number for button must be assigned.

Type 23 * No Alarm Response

- Can be used on a zone when an output relay action is desired, but with no accompanying alarm (e.g., lobby door access).

Type 24 Silent Burglary

- Usually assigned to all sensors or contacts on exterior doors and windows where bells and/or sirens are NOT desired.
- Provides an instant alarm, with NO audible indication at any keypad or external sounder, if the zone is faulted when the system is armed in the Away, Stay, Instant, or Maximum modes.
- A report is sent to the central station.

Type 77 Keyswitch

- Assign to zone wired to a keyswitch.
- Do not use input type "BR" devices with this zone type.

Type 81 AAV Monitor Zone

- Assign to zone connected to AAV module.
- Monitors 2-way voice sessions as follows:
 - When the zone is faulted, all alarm sounding and dialer reporting stops, except for fire alarms, which immediately terminate the voice session and cause a fire report to be sent.
 - When the zone is restored (session ended), sounding resumes (if bell timeout has not expired) and reports that were stopped are sent.

Type 90 Configurable

Allows for various custom responses. Options include response to entry/exit delays, response opens/shorts, types of alarm/trouble sounding, dial delay, and unique Contact ID report codes. UL installations: Zone Type 90 may not be used as fire or burglar alarm zones on fire or UL burglar alarm installations.

- * The system can still be armed when these zone types are in a faulted condition.

SYSTEM COMMUNICATION

This system accommodates several formats for reporting alarms and other system conditions to the Central Station. When the panel calls the Central Station receiver, it waits to hear a “handshake” frequency from the receiver to confirm that the receiver is on-line and ready to receive its message. Once the panel hears the handshake it is programmed to listen for, it sends its message. The panel then waits for a “kissoff” frequency from the receiver acknowledging that the message was received and understood.

If the handshake frequency is not given or is not understood by the panel, the panel will not send its message. Once the handshake frequency is received and understood by the panel, the panel sends its message. If there is an error in the transmission (the receiver does not receive a “valid” message), the kissoff frequency is not given by the Central Station receiver.

The panel makes a total of eight attempts to the primary telephone number and eight attempts to the secondary telephone number (if programmed) to get a valid message through. If the panel is not successful after its numerous attempts, the keypad displays COMM. FAILURE (on alpha keypads) or FC (on fixed-word keypads).

Report Code Formats

The following chart indicates the types of (handshake/kissoff) frequencies and formats that the panel supports.

FORMAT	HANDSHAKE	TRANSMITS DATA	KISSOFF	TRANSMIT TIME
Low Speed 3+1, 4+1, 4+2	1400 Hz	1900Hz (10PPS)	1400 Hz	Under 15 secs (Standard report)
Sescoa/Rad 3+1, 4+1, 4+2	2300 Hz	1800Hz (20PPS)	2300 Hz	Under 10 secs (Standard report)
Express 4+2	1400–2300 Hz	DTMF (10 cps)	1400 Hz	Under 3 secs
Contact ID	1400–2300 Hz	DTMF (10 cps)	1400 Hz	Under 3 secs

The following table describes each format in greater detail.

FORMAT TYPE	DESCRIPTION
3+1 and 4+1 Standard Formats	Comprises a 3- (or 4-) digit subscriber number and a single-digit report code (e.g., Alarm, Trouble, Restore, Open, Close, etc).
3+1 and 4+1 Expanded Formats	Comprises a 3- (or 4-) digit subscriber number and a two-digit report code. The first digit is displayed on the first line. On the second line, it is repeated 3 (or 4) times and is followed by the second, “expanded” digit.
4+2 Format	Comprises a 4-digit subscriber number and 2-digit report code.
ADEMCO Contact ID Reporting Format	Comprises a 4 or 10-digit subscriber number (depending on format selected), 1-digit event qualifier (“new” or “restore”), 3-digit event code, and 3-digit zone number, user number, or system status number.

The following table lists codes for reports sent in different formats:

Type of Report	Code for 3+1/4+1 Standard	Code for 3+1/4+1 Expanded	Code for 4+2
Alarm	SSS(S) A	SSS(S) A AAA(A) Z	SSSS AZ
Trouble	SSS(S) T	SSS(S) T TTT(T) t	SSSS Tt
Bypass	SSS(S) B	SSS(S) B BBB(B) b	SSSS Bb
AC Loss	SSS(S) E	SSS(S) E EEE(E) A _C	SSSS EA _C
Low Batt	SSS(S) L	SSS(S) L LLL(L) L _B	SSSS LL _B
Open	SSS(S) O	SSS(S) O OOO(O) U	SSSS OU
Close	SSS(S) C	SSS(S) C CCC(C) U	SSSS CU
Test	SSS(S) G	SSS(S) G GGG(G)g	SSSS Gg
Restore Alarm	SSS(S) R	SSS(S) R RRR(R) Z	SSSS RZ
AC Restore	SSS(S) R _A	SSS(S) R _A R _A R _A R _A (R _A)A _C	SSSSR _A A _C
LoBat Res.	SSS(S) R _L	SSS(S) R _L R _L R _L R _L (R _L)L _B	SSSS R _L L _B
Trouble Res.	SSS(S) R _T	SSS(S) R _T R _T R _T R _T (R _T)t	SSSS R _T t
Bypass Res.	SSS(S) R _B	SSS(S) R _B R _B R _B R _B (R _B)b	SSSS R _B b

Where:

SSS or SSSS = Subscriber ID
 A = Alarm Code–1st digit
 Z = Typically Zone Number*–2nd digit
 Tt = Trouble Code (1st & 2nd digits)
 Bb = Bypass Code (1st & 2nd digits)
 EA_C = AC Loss Code (1st & 2nd digits)
 LL_B = Low Battery Code (1st & 2nd digits)
 O = Open Code–1st Digit

C = Close Code–1st Digit
 U = User Number (in hex)
 Gg = Test Code (1st & 2nd digits)
 R = Restore Code (Alarm)
 R_Tt = Restore Code (Trbl) 1st & 2nd digits
 R_Bb = Restore Code (Byps) 1st & 2nd digits
 R_AAC = Restore Code (AC) 1st & 2nd digits
 R_LLB = Restore Code (Bat) 1st & 2nd digits

*Zone numbers for: * & #, or B = 99 1 + *, or A = 95 Duress = 92
 3 + #, or C = 96

Ademco Contact ID[®]

The Ademco Contact ID[®] Reporting Format comprises the following:
 4-digit or 10-digit subscriber number (depending on format selected).
 1-digit event qualifier (“new” or “restore”).
 3-digit event code.
 3-digit zone number, user number, or system status number (see the following page).

Ademco Contact ID[®] Reporting takes the following format: CCCC(CCCCC) Q EEE GG ZZZ

where:

CCCC(CCCCC) = Customer (subscriber) ID
 Q = Event qualifier, where:
 E = new event , and R = restore
 EEE = Event code (3 hexadecimal digits)
Note: For a complete list of event codes, refer to the central office receiver manual.
 GG = Partition number (always sent as “01” for this control; system messages show “00.”)
 ZZZ = Zone/contact ID number reporting the alarm, or user number for open/close reports.
 System status messages (AC Loss, Walk Test, etc.) contain zeroes in the ZZZ location.

TABLE OF CONTACT ID EVENT CODES

Code	Definition
110	Fire Alarm
121	Duress
122	Alarm, 24-hour Silent
123	Alarm, 24-hour Audible
131	Alarm, Perimeter
132	Alarm, Interior
134	Alarm, Entry/Exit
135	Alarm, Day/Night
137	Alarm, Tamper
143	Alarm, Expansion Module
145	ECP Module cover tamper
146	Silent Burglary
150	Alarm, 24-Hour Auxiliary/Monitor zone
162	Carbon Monoxide
301	AC Power
302	Low System Battery/Battery Test Fail
305	System Reset (Log only)
321	Bell/Siren Trouble
333	Trouble, Expansion Mod. Supervision
341	Trouble, ECP Cover Tamper
344	RF Receiver Jam
351	Telco Line Fault
353	Long Range Radio Trouble
373	Fire Loop Trouble
374	Exit Error Alarm
380	Global Trouble, Trouble Day/Night

Code	Definition
381	RF Sensor Supervision
382	Supervision Auxiliary Wire Zone
383	RF Sensor Tamper
384	RF Sensor Low-battery
393	Clean Me
401	Disarmed, Armed AWAY, Armed MAXIMUM
403	Schedule Arm/Disarm AWAY
406	Cancel by User
407	Remote Arm/Disarm (Downloading)
408	Quick Arm AWAY
409	Keyswitch Arm/Disarm AWAY
441	Disarmed/Armed STAY/INSTANT, Quick-Arm STAY/INSTANT
442	Keyswitch Arm/Disarm STAY
459	Recent Close (restore only)
570	Bypass
601	Manually Triggered Dialer Test
602	Periodic Test
606	AAV to Follow
607	Walk Test Entered/Exited
623	Event Log 80% Full
625	Real-Time Clock was Changed (log only)
627	Program Mode Entry (log only)
628	Program Mode Exit (log only)
642	Latch Key (log only)
750 - 789	Reserved for Configurable Zone Type report codes (check with central station when using these codes)

TABLE OF DEVICE ADDRESSES

This Device	Uses Address	Reports as††	Enabled By...
RF Receiver	00	100	*56 zone programming: input device type entry
Communication Device (LRR)	03	103	automatic if communication device enabled in *29 Menu mode
4286 Voice Module	04	104	automatic if phone module access code field *28 enabled
4204 Relay Module	12	112	*79 output device programming: entered at device address prompt:
Keypads:			data field programming as listed below:
keypad 1	16	n/a	always enabled, all sounds enabled.
keypad 2	17	n/a	data field *190
keypad 3	18	n/a	data field *191
keypad 4	19	n/a	data field *192
keypad 5	20	n/a	data field *193
keypad 6	21	n/a	data field *194
keypad 7	22	n/a	data field *195
keypad 8	23	n/a	data field *196
5800TM Module	28	n/a	automatic

†† Addressable devices are identified by "1" plus the device address when reporting. Enter report code for zone 91 to enable addressable device reporting (default = reports enabled). See field *199 for addressable device (ECP) 3-digit/2-digit identification keypad display options.

UL NOTICES

- Entry Delay No. 1 and No. 2 (fields *35, *36) cannot be greater than 30 seconds for UL Residential Burglar Alarm installations, and entry delay plus dial delay should not exceed 1 minute. For UL Commercial Burglar Alarm installations, total entry delay may not exceed 45 seconds.
- For UL Commercial Burglar Alarm and UL Residential Burglar Alarm installations with line security, total exit delay time must not exceed 60 seconds.
- The maximum number of reports per armed period (field *93) must be set to "0" (unlimited) for UL installations.
- Periodic testing (see scheduling mode) must be at least every 24 hours.
- Alarm Sounder plus Auxiliary Power currents must not exceed 600mA total for UL installations (Aux power 500mA max.).
- If used, the audible alarm device(s) must be placed where it/they can be heard by all users.
- For UL commercial burglar alarm installations the control unit must be protected from unauthorized access. The tamper switch installed to protect the control unit enclosure door is suitable for this purpose.
- Remote downloading without an alarm company technician on-site (unattended downloading) is not permissible for UL installations.
- Auto-disarming is not a UL Listed feature.
- As SIA limits for delay of alarm reporting and sounding can exceed UL limits for commercial and residential applications, the following UL requirements per UL681 are provided:
The maximum time that a control unit shall be programmed to delay the transmission of a signal to a remote monitoring location, or to delay the energizing of a local alarm sounding device to permit the alarm system user to enter and disarm the system, or to arm the system and exit shall not exceed:
 - 60 seconds for a system with standard line security or encrypted line security,
 - 120 seconds for a system without standard line security or encrypted line security, or
 - 120 seconds for a system that does not transmit an alarm signal to a remote monitoring location.







SIA QUICK REFERENCE GUIDE

- *31 Single Alarm Sounding per Zone: If "0" selected, "alarm sounding per zone" will be the same as the "number of reports in armed period" set in field *93 (1 if one report, 2 if 2 reports, unlimited for zones in zone list 7).
- *34 Exit Delay: Minimum exit delay is 45 seconds.
- *35/*36 Entry Delay 1 and 2: Minimum entry delay is 30 seconds.
- *37 Audible Exit Warning: Feature always enabled; field does not exist.
- *39 Power Up in Previous State: Must be "1," power up in previous state.
- *40 PABX Access Code or Call Waiting Disable: If call waiting is used, call waiting disable option in field *91 must be set.
- *50 Burglary Dial Delay: Delay must be minimum of 30 seconds.
- *59 Exit Error Alarm Report Code: Always enabled.
- *68 Cancel Report Code: Default is "code enabled."
- *69 Recent Closing Report Code: Always enabled.
- *91 Option Selection: Exit Delay option should be enabled. If call waiting is used, Call Waiting Disable must be set to "1" (enabled).
- *93 No. reports in Armed Period: Must be set for 1 or 2 report pairs.

5800 SERIES TRANSMITTER INPUT LOOP IDENTIFICATION

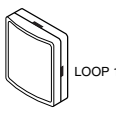
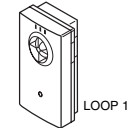
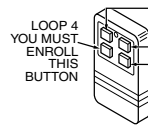
All of the transmitters illustrated have one or more unique factory assigned input (loop) ID numbers. Each of the inputs requires its own programming zone (e.g., a 5804's four inputs require four programming zones). For information on any transmitter not shown, refer to the instructions accompanying that transmitter for details regarding loop numbers, etc.

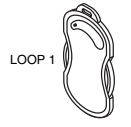
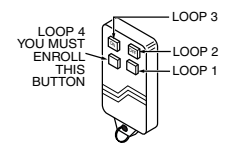
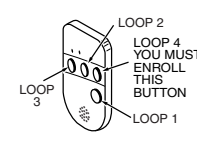
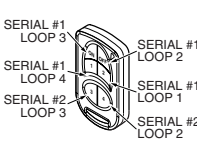
UL NOTE: The following transmitters are not intended for use in UL installations: 5802MN, 5802MN2, 5804, 5804BD, 5814, 5816TEMP, 5819, 5819WHS & BRS, and 5850.
The 5827BD and 5800TM can be used in UL Listed Residential Burglar installations.

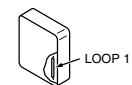
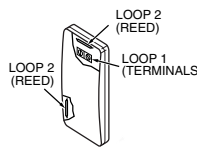
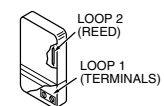
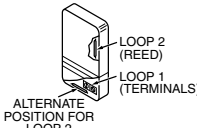
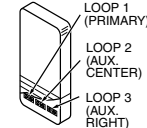
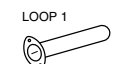
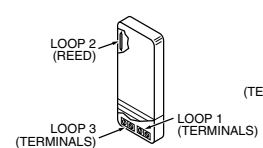
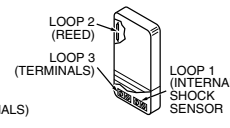
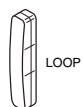
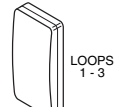
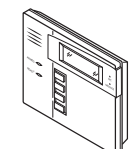
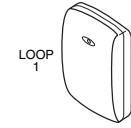
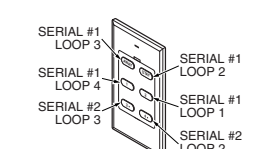
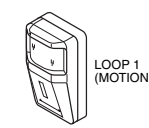
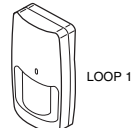
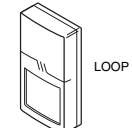
 5800CO ENROLL AS "RF"	 5800Micra ENROLL AS "RF"	 5800SS1 ENROLL AS "RF"	 5800WAVE SET HOUSE ID ENROLL AS "RF"	 5801 ENROLL AS "UR OR 'RF'"	 5802 MN ENROLL AS "UR" OR "RF"
 5802 MN2 ENROLL AS "UR" OR "RF"	 5804/5804E ENROLL AS "BR"	 5804BD/5804BDV ENROLL AS "BR" SET HOUSE ID	 5805-6 ENROLL AS "BR"	 5806/5806W3 5808/5808LS1/5808W3 ENROLL AS "RF"	 5809 ENROLL AS "RF"
 5814 ENROLL AS "RF"	 5815 ENROLL AS "RF"	 5816 ENROLL AS "RF"	 5816MN ENROLL AS "RF"	 5817 ENROLL AS "RF"	 5818MNL ENROLL AS "RF"
 5819 ENROLL AS "RF"	 5819S (WHS & BRS) ENROLL AS "RF"	 5820/5820L ENROLL AS "RF"	 5821 ENROLL AS "RF"	 5828/5828V SET HOUSE ID	 5853 ENROLL AS "RF"
 5878 ENROLL AS "BR"	 5890/5890PI ENROLL AS "RF"	 5894PI ENROLL AS "RF"	 5897-35 ENROLL AS "RF"		

5800-003-V0

SCHEDULE WORKSHEET

(installer code + [#] + [6] [4]; master code can only access schedule 01 and events 00-07)

No.	Event (see list below)	Device No. for "01" events: enter 01-04	Group No. for "02" events: enter 1-8	Start Time/ Days	Stop Time/ Days	Repeat (1-4)	Random (yes/no)
01 (user)							
02 (installer)							

Events: Master/Installer
 00 = clear event
 01 = device on/off
 02 = user access
 03 = latch key report
 04 = forced STAY arm
 05 = forced AWAY arm
 06 = auto disarm
 07 = display "reminder"

Installer Only
 10 = display custom words 8-10
 11 = periodic test report

Repeat Options: 0 = none; 1 = repeat weekly; 2 = repeat every other week; 3 = repeat every third week; 4 = repeat every fourth week

*56 ZONE PROGRAMMING WORKSHEET

[default shown in brackets]

Zone	Zn Type	Report	Hardware Type	Rsp. Time	Location	
1	[01]		[EOL]	[1]		
2	[01]		[EOL]	[1]		
3	[03]		[EOL]	[1]		
4	[03]		[EOL]	[1]		
5	[03]		[EOL]	[1]		
6	[03]		[EOL]	[1]		
Zone	Zn Type	Report	Input Type	Loop	Serial No.	Location
9						
10						
11						
12						
13						
14						
15						
16						
17						
18						
19						
20						
21						
22						
23						
24						
49			[BR]			
50			[BR]			
51			[BR]			
52			[BR]			
53			[BR]			
54			[BR]			
55			[BR]			
56			[BR]			
95	[00]		N/A	N/A	N/A	keypad [1] / [*]
96	[00]		N/A	N/A	N/A	keypad [3] / [#]
99	[06]		N/A	N/A	N/A	keypad [*] / [#]

NOTES:
 Zone Type: see chart on page 7;
 Hardwire Type (zns 1-6):
 0 = EOL
 1 = NC
 2 = NO
 Input Type:
 3 = RF (zones 9-24)
 4 = UR (zones 9-24)
 5 = BR (zones 49-56)
 Response Time:
 0 = 10msec
 1 = 350msec
 2 = 700msec
 3 = 1.2 sec
Reserved Zones
 91 = addressable device report enable/disable default zone type = [05].
 92 = Duress report enable/disable

*57 FUNCTION KEY PROGRAMMING WORKSHEET

Option	Function	A	B	C	D	Comments
01	Paging					
02	Time Display					
03	Arm AWAY					
04	Arm STAY					
05	Arm NIGHT-STAY					
06	Step Arming					
07	Device Activation					Device:
08	Comm. Test					
09	Macro Key					
00	Emergency Keys:	zone 95	zone 99	zone 96	paging	
	Personal Emergency				n/a	
	Silent Alarm				n/a	
	Audible Alarm				n/a	
	Fire				n/a	

Emergency Keys: A = paired keys [1] / [*] (zone 95); B = paired keys [*] / [#] (zone 99); C = paired keys [3] / [#] (zone 96)

*79 RELAY MAPPING WORKSHEET

(Must program before using *80)

Output No.	Module Addr.	Pos (1-4)	Description
01	12		
02	12		
03	12		
04	12		
17			On-Board Trigger 1: Norm output =
18			On-Board Trigger 2: Norm output =

*80 OUTPUT DEFINITIONS WORKSHEET

Output Function Number 1-12	Activation Type and Detail			Event (for zone list/activated by)		Action 0 = off 1 = close 2 secs 2 = stay closed 3 = pulse 4 = toggle 5 = duration 1†† 6 = duration 2††	Output Number 1-4 17, 18	Device Type R = relay T = trigger
	Activated by 0=delete 1=zn list 2=zn type 3=zn no.	Zone List (ZL) 1-8 = list	Zone Type (ZT) (see table below)	Zone No. (ZN) 00=none 01-06, 09-24 49-56	By Zone List 0 = restore 1 = alarm 2 = fault 3 = trouble			
1								
2								
3								
4								
5								
6								
7								
8								
9								
10								
11								
12								

ZONE TYPE/SYSTEM OPERATION – Choices for Zone Types are:

00 = Not Used	05 = Trouble Day/Alarm Night	10 = Interior w/Delay	24 = Silent Burglary
01 = Entry/Exit#1	06 = 24 Hr Silent	12 = Monitor Zone	77 = Keypad
02 = Entry/Exit#2	07 = 24 Hr Audible	14 = Carbon Monoxide	81 = AAV Monitor Zone
03 = Perimeter	08 = 24 Hr Aux	16 = Fire w/Verification	90 = Configurable
04 = Interior Follower	09 = Fire	23 = No Alarm Response	

Choices for System Operation are:

20 = Arming–Stay	38 = Chime	52 = KISSOFF
21 = Arming–Away	39 = Any Fire Alarm	54 = Fire Zone Reset
22 = Disarming (Code + OFF)	40 = Bypassing	58 = Duress
31 = End of Exit Time	41 = AC Power Failure	60 = AAV Trigger
32 = Start of Entry Time	42 = System Battery Low	66 = Function key†
33 = Any Burglary Alarm	43 = Communication Failure	67 = Bell Failure
36 = **At Bell Timeout***		68 = Telco Line Fault
		78 = Keypad Red LED†††
		79 = Keypad Green LED†††

Note: In normal operation mode:
Code + # + 7 + NN Key Entry **starts** Device
Code + # + 8 + NN Key Entry **stops** Device

*** Or at Disarming, whichever occurs earlier.
† Use *57 Menu mode to assign the function key.
†† Duration is set in program field *177.
††† Device action not used for these choices.

*81 ZONE LISTS WORKSHEET

Record desired zone numbers below, noting that a list may include *any* or *all* of system's zone numbers.

List No.	Used For...	Contains These Zones...
01	General Purpose (GP)	
02	General Purpose	
03	Chime-by-Zone or GP	
04	Cross Zones	
05	Night-Stay Zones or GP	
06	Dial Delay Disable or GP	VISTA-10PSIA ; see field *50 for Dial Delay Disable option
07	Unlimited Reports or GP	VISTA-10PSIA ; see field *93 for Unlimited Reports option
08	General Purpose	
09	Zones activating pager	

VARIOUS SYSTEM TROUBLE DISPLAYS

Alpha Display	Fixed Disp.	Meaning
ALARM CANCELED	CA	will appear if an exit or interior zone contained a fault during closing at the time the Exit Delay ended (e.g., exit door left open), but the system was disarmed during the Entry Delay time. The alarm sounder and keypad sound continuously, but stop when the system is disarmed. No message will be transmitted to the central station.
EXIT ALARM	EA	will appear when the Exit Delay ends if an exit or interior zone contained a fault during closing. The alarm sounder and keypad sound continuously until the system is disarmed (or timeout occurs). An "Exit Alarm" message is sent to the central station. Also results if an alarm from an exit or interior zone occurs within 2 minutes after the end of an Exit Delay.
CHECK	CHECK	indicates that a problem exists with the displayed zone(s) and requires attention.
ALARM 1xx FAULT 1xx CHECK 1xx	1xx 1xx 1xx 91	indicates that communication between control and a zone expander or wireless receiver is interrupted, where "xx" is the device address. Check the wiring and DIP switch settings on the units. If field *199 is set to "1," all ECP module problems are displayed as "91." If there are wireless sensors in the system, the Check condition may also be caused by some change in the environment that prevents the receiver from receiving signals from a particular sensor.
SYSTEM LO BAT	BAT	with no zone number indicates that the system's main standby battery is weak.
LO BAT	BAT	with a zone number and a once-per-minute beeping at the keypad indicates that a low-battery condition exists in the wireless sensor displayed (zone "00" indicates a wireless keypad). If the battery is not replaced within 30 days, a "CHECK" display may occur. NOTE: Some wireless sensors use a non-replaceable long-life battery which requires replacement of the entire unit at the end of battery life (e.g., 5802, 5802CP).
Busy-Standby	dl	If this remains displayed for more than 1 minute, the system is disabled.
Modem Comm	CC	The system is in communication with the central station for change of function or status verification.
no display	no display	Power Failure If there is no keypad display at all and the LEDs are unlit, operating power (AC and battery) for the system has stopped and the system is inoperative. If the message "AC LOSS" (Alpha display keypads) or "NO AC" (Fixed-Word display keypads) is displayed, the keypad is operating on battery power only. If the battery standby capacity is used up during a prolonged AC power outage, the control's power will shut down to minimize deep discharge of the battery.
Comm. Failure	FC	A communication failure has occurred.
Open Circuit	OC	The keypad is not receiving signals from the control and sees an open circuit.
Long Rng Trbl	bF	Backup LRR communication failure.
Bell Failure	70	Bell supervision failure.
RCVR Jam	90	RF jam detected.
KEYPAD LOW BAT	00 BAT	Wireless keypad low battery
Phone Okay	Cd	The dialer test has been successful (CID code 601).
Dialer Off	d0	The dialer is disabled.
Test in Progress	dd	Walk test mode is active (CID code 607).
Upload Completed	dC	The upload or download session was completed.
Upload Failed	dF	The upload or download session failed before completion.

Honeywell

2 Corporate Center Drive, Suite 100
P.O. Box 9040, Melville, NY 11747
Copyright © 2003 Honeywell International Inc.

www.honeywell.com/security



K0735PRV4 10/08 Rev. B